

# **Yacht Devices**

## **User Manual**

**Yacht Devices Engine Gateway YDEG-04**

also covers models

YDEG-04N, YDEG-04R

Firmware version

1.31

**2019**

## Package Contents

Device	1 pc.
This Manual	1 pc.
Plug for Deutsch 6-pin connector	1 pc.
Stickers for MicroSD slot sealing	6 pc.

© 2019 Yacht Devices Ltd. Document YDEG04-011. May 21, 2019. Web: <http://www.yachtd.com/>



Yacht Devices Engine Gateway YDEG-04 is certified by the National Marine Electronics Association.

NMEA 2000® is a registered trademark of the National Marine Electronics Association. SeaTalk NG is a registered trademark of Raymarine UK Limited. Garmin® is a registered trademark of Garmin Ltd. Volvo Penta® is a registered trademark of Volvo Trademark Holding AB. BRP is a registered trademark of Bombardier Recreational Products Inc.

# Contents

Introduction .....	4
Warranty and Technical Support .....	6
I. Product Specification .....	7
II. MicroSD Slot and Card's Compatibility .....	9
III. Installation and Connection to NMEA 2000 Network .....	11
IV. Connection to Engine Network .....	12
IV.1 Connection to a Volvo Penta Engine .....	13
IV.1.1 Connection to EFI Engines (Gasoline, 2004-2005) .....	14
IV.1.2 Connection to EGC Engines (Gasoline, 2005 and Later) .....	15
IV.1.3 Connection to EDC III (EMS2), EDC IV (Diesel) .....	15
IV.1.4 Connection to EVC-A MC (EVC-MC, EVCmc) Engines (2004-2006, Diesel and Gasoline) .....	15
IV.1.5 Connection to EVC-A EC (EVC-EC, EVCec) Engines (2002-2005) .....	16
IV.1.6 Connection to Other EVC Versions and MDI (Engines from After 2005, EVC-B and Later) .....	17
IV.2 Connection to BRP Rotax Engines .....	20
IV.3 Connection to J1939 Engines .....	22
IV.4 Connection to SmartCraft Engines .....	23
V. Configuring the Device .....	25
VI. Display Engine and Transmission Status (Warnings) .....	42
VII. LED Signals .....	47
VIII. Firmware Updates .....	48
IX. Recording Data and Diagnostics of the Engine Interface .....	50
Appendix A. Troubleshooting .....	51
Appendix B. Bits for Engine and Transmission Status .....	53
Appendix C. NMEA 2000 and J1939 Messages Supported by the Device .....	55
Appendix D. Example of a Configuration File YDEG.TXT .....	59
Appendix E. Device Connectors .....	63
Appendix F. Adaptor for 8-pin EVC/Vodia Connector .....	65
Appendix G. Adaptor Cable for BRP Diagnostics Connector .....	66
Appendix H. SmartCraft Data Supported by the Device .....	67

## Introduction

The Device is a gateway from VVolvo Penta (EVC all versions, MDI, EDC III, EMS2, EDC IV, EFI with MEFI4B or later, EGC all versions), J1939 (including some Yanmar 4JH engines), SmartCraft (Mercury, MerCruiser) and BRP CAN (Bombardier Recreational Products, for example BRP Rotax 1503 engine) networks (engine networks) to a NMEA 2000 marine digital network. With it, you can see engine revolutions, temperature, working hours and other information on the screen of a chart plotter and other display devices on an NMEA 2000 network.

The Gateway was initially developed specifically for Volvo Penta engines with an EVC system, but it can be used with engines of other manufacturers (adaptor cable may be required). On most vessels with Volvo Penta or J1939 engines, the Device starts working upon installation, with no configuration needed. Please, read the corresponding section of the manual before connecting.

We're happy to point out that the Gateway has a wealth of diagnostics capabilities and settings. Because of this, it can often be used on vessels where there are complications with similar equipment from various manufacturers.

The YDEG-04 is compatible with a wide range of NMEA 2000 devices. Raymarine SeaTalk NG, Simrad SimNet and Furuno CAN networks are branded versions of NMEA 2000 and differ only in the type of connectors. In its devices, Garmin uses the NMEA 2000 Micro connector that is compatible with the DeviceNet Micro connector. Our devices are supplied with different types of NMEA 2000 connectors, making it possible to connect them to networks of different manufacturers without any adapters. The Device model is shown on the case.

The model YDEG-04R has a connector similar to Raymarine SeaTalk NG Female. The model YDEG-04N has a connector similar to NMEA 2000 Micro Male, DeviceNet Micro Male and Garmin NMEA 2000 Male (see Appendix E). To connect to other types of NMEA 2000 networks, a cable adapter is required (it is not supplied with the Device and must be purchased separately).

The product with factory settings does not send data to engine networks, and it has a high-voltage galvanic isolation between the NMEA 2000 and engine network. Installing the Device in accordance with the manual should not have any effect on the work of the engine network. Power is supplied by the NMEA 2000 network. The connector to the engine network supplies power only for isolated

transceiver of the engine network. The Device is designed to work on 12V or 24V engine networks.

The devices is equipped with a slot for a MicroSD card which can be used to configure its settings (loading a text file with the settings), updates for the Device firmware. The card can also serve to record the data from the engine network for configuration and diagnosis of the Device.

We thank you for purchasing our Devices and wish you happy voyages!

## Warranty and Technical Support

1. The Device warranty is valid for two years from the date of purchase. If a Device was purchased in a retail store, when applying under a warranty case, the sale receipt may be requested.
2. The Device warranty is terminated in case of violating the instructions of this Manual, case integrity breach, repair or modification of the Device without manufacturer's written permission.
3. If a warranty request is accepted, the defective Device must be sent to the manufacturer.
4. The warranty liabilities include repair and replacement of the goods and do not include the cost of equipment installation and configuration, as well as shipping the defective Device to the manufacturer.
5. Responsibility of the manufacturer in case of any damage as a consequence of the Device operation or installation is limited to the Device cost.
6. The manufacturer is not responsible for any errors and inaccuracies in guides and instructions of other companies.
7. The Device requires no maintenance. The Device's case is non-dismountable.
8. If the event of a failure, please refer to Appendix A. before contacting the technical support.
9. The manufacturer accepts applications under the warranty and provides technical support only via e-mail or from authorized dealers.
10. Contact details of the manufacturer and a list of the authorized dealers are published on the website: <http://www.yachtd.com/>.

## I. Product Specification

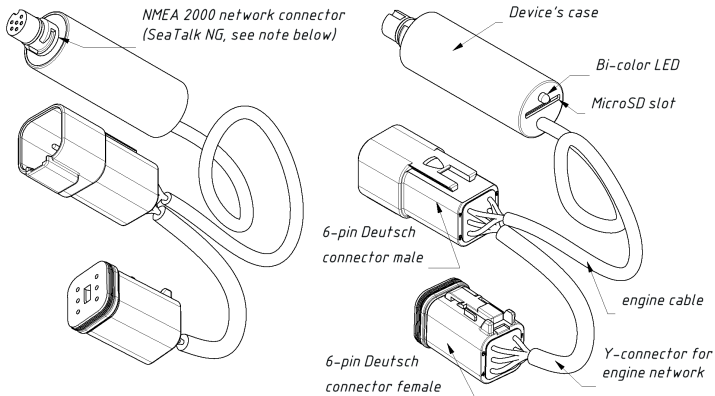

Figure 1. Drawing of YDEG-04R model of Gateway

Our devices are supplied with different types of NMEA 2000 connectors. Models with suffix R at the end of model name are equipped with NMEA 2000 connectors compatible with Raymarine SeaTalk NG (as at the picture above). Models with suffix N are equipped with NMEA 2000 Micro Male connectors (see Appendix E).

<b>Device parameter</b>	<b>Value</b>	<b>Unit</b>
Operating voltage (from an NMEA 2000 network)	10..16	V
Protection against reverse polarity	Yes	—
Average current consumption	38	mA
Load equivalency number	1	LEN
Operating temperature range	-20..55	°C
Isolation between NMEA 2000 and engine network	2500	V <sub>RMS</sub>
Supply voltage from engine network	10..30	V
Average current consumption (engine network)	13	mA
Engine cable length (to Deutsch male connector)	500	mm
Device's case length (without connector)	54	mm
Weight without MicroSD card	75	g



Yacht Devices Ltd declares that this product is compliant with the essential requirements of EMC directive 2014/30/EU.



Dispose of this product in accordance with the WEEE Directive. Do not mix electronic disposal with domestic or industrial refuse.



## II. MicroSD Slot and Card's Compatibility

The Device has a slot for a MicroSD card that allows you to configure the Device (see Section V) and update the firmware (see Section VIII).

Since the MicroSD slot is usually not in use when the Device is working, we recommend sealing it with the sticker that is included with the Device or with a piece of tape to prevent water from entering the Device through the slot.



*The Device slot has a 'push-push' mechanism that works on a spring and ensures proper card fixation. Improper loading or unloading (withdrawing your finger too quickly or not waiting for the click) can result in the card being propelled out of the Device up to 5 meters. To avoid possible eye injury, loss of or damage to the card, and other hazards, insert and remove the card with caution.*

The Device supports MicroSD memory cards of all sizes and classes. The MicroSD card must be formatted on a personal computer before use in the Device. The Device supports the following file systems: FAT (FAT12, FAT16, MS-DOS) and FAT32. It does not support exFAT, NTFS, or any other file systems.

Be careful when inserting the MicroSD card into the Device. The card is inserted with the label side toward the LED and with the pin side toward the engine cable.

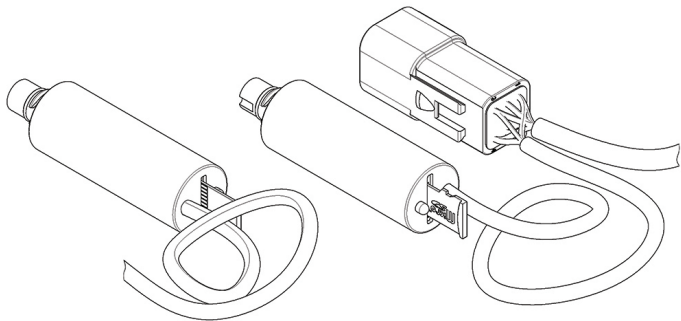

*Figure 1. Device with MicroSD card (pin side visible at left, label side at right)*

### III. Installation and Connection to NMEA 2000 Network

The Device requires no maintenance. When deciding where to install the Device, choose a dry mounting location. Avoid places where the Device can be flooded with water, this can damage it.

The Device is directly connected to the network backbone without a drop cable. Before connecting the Device, turn off the bus power supply. Refer to the manufacturer's documentation if you have any questions regarding the use of connectors:

- SeaTalk NG Reference Manual (81300-1) for Raymarine networks
- Technical Reference for Garmin NMEA 2000 Products (190-00891-00) for Garmin networks

After connecting the Device, close the lock on the connection to ensure its water resistance and reliability.

The Device has an LED which flashes red or green. After turning the power in the NMEA 2000 network on, the Device's LED will give a series of 2 flashes 5 seconds apart. If this does not happen, see Appendix A.



*If your boat has no NMEA 2000 network installed, you should establish a basic NMEA 2000 network first. You cannot simply connect the Gateway to a NMEA 2000 port of your chart plotter. Many manufacturers offer a "Starter Kit" which contains all that is necessary to establish a basic network and connect two devices:*

- *for Raymarine SeaTalk NG, see Raymarine part number T70134;*
- *for NMEA 2000, see Garmin part number 010-11442-00.*

## IV. Connection to Engine Network



*Read and become fully familiar with the contents of this section. Never connect the Device to the connector that 'just looks right' until you are sure about its wiring. If you have any doubts, ask a specialist.*

Modern engine networks may seem very complicated and may have many similar connectors with different wiring and different purposes. Some engines, which only differ by one character in the model name, may have a vastly different electronics and different wiring. Be sure that you are using the appropriate manual. Usually, a manual lists the colors of wires, and you may check a connector by the color of the incoming wires.

Never disconnect or connect any connectors when the circuit breaker is ON. The entire installation process must be performed with no power coming into the engine network and with the engines disconnected at the circuit breaker.

The Device uses two data lines called «CAN HIGH» and «CAN LOW», and two power supply lines: VCC (positive) and GND (negative, ground), see Appendix E. We strongly recommend checking the engine connector wiring in the engine's manual, and verifying your engine connector wiring with a simple multimeter to be sure that you find the right connector:

- turn OFF the circuit breaker and check resistance between the CAN HIGH and CAN LOW pins, it must be 60 – 120 Ohm;
- turn on the circuit breaker (for some models ignition also should be on) and check voltage on the VCC and GND pins (be careful not to short-circuit anything) of the connector, it must be 12 – 24 V.

## IV.1 Connection to a Volvo Penta Engine

The Device is compatible with all versions of Volvo Penta EVC, including the first version EVC-A (also known as EVC-MC or EVC-EC); engines with MDI (Mechanical Diesel Interface, D1 and D2 series); with engines equipped with EDC III (EMS2) and EDC IV systems; with gasoline engines equipped with EFI system (MEFI4B or MEFI5 controllers are supported, with or without EVC system installed); with gasoline engines equipped with Volvo Penta EGC (with or without EVC system installed).

The Gateway is compatible with most of engines manufactured since 2004 and even with some engines manufactured before 2000. Most modern engines (manufactured since 2006) are equipped with different versions of EVC-B, EVC-C, EVC-D, or EVC-E. If any of these versions are fitted on your boat, (regardless if diesel or gasoline engine) please refer section IV.1.6 for installation details. Please also see IV.1.6 for engines with MDI (Mechanical Diesel Interface), which are used in the popular D1 and D2 series of engines (for example, D2-40F).

For Volvo Penta KAD and TAMD engines (EDC I and EDC II), and for engines with J1708/J1587 interface, please, use another our product, J1708 Engine Gateway YDES-04 (see [www.yachtd.com](http://www.yachtd.com) for details).



*Do not connect the Device to any connectors labeled “Panel”, “Diagnostics”, “Datalink”, “Aux” or “Senders”. If you have any doubts, ask a specialist.*

When connected to both the NMEA 2000 and the engine network, the Device should give a signal indicating data in the engine network (see Section VII) immediately after the ignition is turned on.



*The plug supplied with the Device is not a terminator of a CAN bus. It connects two CAN buses on the 6-pin connector (see Appendix E).*

## IV.1.1 Connection to EFI Engines (Gasoline, 2004-2005)

Only engines equipped with an MEFI4B controller and later are supported (for example, 8.1 Gi-E, 8.1 OSi-A, 8.1 Gi-EF, 8.1 GXi-D, 8.1 GXi-E and many other). An adaptor cable for the Marine Data Link Connector is required (available in accessories on the ordering page). The cable has both male and female connectors (Y-connector), so you can use diagnostics equipment with the Gateway connected.

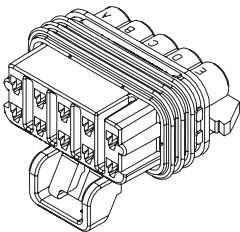

*Figure 1. Marine Data Link Connector (with dust cap removed)*

Note that ten wires must be connected to the Marine Data Link Connector from the engine side. Otherwise, it means that your engine is equipped with an older MEFI version (MEFI3, MEFI4) which is not compatible with the Device.

To get engine tilt/trim data, please, set MEFI4B setting to ON (see V.36). To calibrate tilt/trim settings, see V.37-39.

*Note: you can use the supplied 6-pin plug as a dust cap for the unused Device connector.*

## **IV.1.2 Connection to EGC Engines (Gasoline, 2005 and Later)**

*Note: If an EVC system is fitted, see the EVC section details.*

The Device is compatible with all EGC engines (8.1Gi-H, 8.1GXi-G, 8.1OSi-D and many other).

Device is connecting to EVC/Vodia 8-pin Deutsch connector with adaptor cable (see Appendix F, available in accessories at ordering page). The cable has male and female connectors both (Y-connector), so you can use diagnostics equipment with Gateway connected.

*Note: you can use supplied 6-pin plug as a dust cap for the free Device connector.*

## **IV.1.3 Connection to EDC III (EMS2), EDC IV (Diesel)**

*Note: If an EVC system is fitted, see the EVC section details.*

To connect with EDC III (EMS2) engines, an EVC/Vodia 8-pin adaptor cable (see Appendix F, available in accessories on the ordering page) is required. The adaptor cable must be connected to the engine's 8-pin Deutsch connector, or in line (cable has a built-in Y-connector) between the ECU (Engine Control Unit) and the CIU (Control Interface Unit).

The Gateway is compatible with EDC IV engines, but the wiring may differ depending on the instruments installed. A 6-pin Deutsch Vodia connector usually has four wires (power and J1708) only and cannot be used for a Gateway connection. Please refer your installation diagram and follow the instructions from section IV.3.

For EDC I and EDC II engines, please, use another our product, J1708 Engine Gateway YDES-04 (see [www.yachtd.com](http://www.yachtd.com) for details).

## **IV.1.4 Connection to EVC-A MC (EVC-MC, EVCmc) Engines (2004-2006, Diesel and Gasoline)**

Unlike other EVC engines, EVC-A MC (used in the D3-160A-A engine and some others engines) use the Volcano protocol which is physically compatible with the J1939 protocol, but differs at the software

level. Engine revolutions, coolant temperature, boost pressure, battery voltage and engine hours are supported. The Engine Gateway must be connected in series with the engine and Helm Interface Unit (HIU).

Connections can be made with a «EVC-A MC 12-pin C5:ENGINE» adaptor cable (available in accessories on the ordering page). This cable contains a Y-connector, and must be connected between the C5:ENGINE (grey) connector of HIU (Helm Interface Unit) and the engine cable.

Connection can also be made using an EVC/Vodia 8-pin adaptor cable (see Appendix F, available in accessories on the ordering page). The Y-connector of this cable must be connected between the ECU (Engine Control Unit) and the cable to the HIU. Note that this connection point may be located far from the NMEA 2000 backbone, and an additional NMEA 2000 drop cable may be required.

The multisensor interface is a different CAN network on this ECU, and to get multisensor data (water temperature, depth and speed), an additional Gateway with an «EVC-A Multisensor» adaptor cable (available in accessories on the ordering page) is required. The Y-connector of this adaptor cable must be connected between the C4:MULTISENSOR (yellow) connector of the HIU and the multisensor cable.

*Note: you can use the supplied 6-pin plug as a dust cap for the unused Device connector.*

To activate support of Volcano protocol (required on Gateways connected to both a C5:ENGINE and a C4:MULTISENSOR), the setting VOLCANO=ON must be set (see V.21).

Water temperature, depth and speed can be calibrated with settings V.22-V.24.

## **IV.1.5 Connection to EVC-A EC (EVC-EC, EVCec) Engines (2002-2005)**

This type of EVC system used on D4 and D6 engines was manufactured from 2002-2005 (for example, D4-210A-A). An adaptor cable, «EVC-A EC 12-pin X5:MULTILINK» is required (available in accessories on the ordering page). The Y-connector of this cable must be connected between the X5:MULTILINK port of the HCU (Helm Control Unit) and the sync cable.



One Gateway is enough for a twin-engine installation.

*Note: you can use the supplied 6-pin plug as a dust cap for the unused Device connector.*

#### **IV.1.6 Connection to Other EVC Versions and MDI (Engines from After 2005, EVC-B and Later)**

This connection can be made at the following points (please, read also the details below):

- If the system has an EVC tachometer (with a needle gauge and a small LCD display) connected by a 6-pin Deutsch connector (see Fig. 2 on the next page), the best option is to connect the Gateway in-line with a tachometer (no extra cables are required, the Gateway is equipped with a 6-pin Y-connector);
- If the system has an HCU (Helm Control Unit) with a 6-pin «Multilink» connector (usually the connector and/or the cable label are yellow), the Gateway can be connected to this port (in line with the existing cable);
- If the system has a Multilink Hub (casing usually made completely of yellow plastic, 6-pin connectors), the Gateway can be connected to any port of the hub.

If the engines are connected to a single network (joined with a sync cable), one Device is adequate for transferring data from all engines to the NMEA 2000 network. The Device supports up to 8 engines on a network. If the engines are not united on a single network, a separate Device will be needed for each one.

The basic test is to switch the cables of the EVC tachometers. If the port tachometer shows data of the starboard engine, it means that you need a dedicated Gateway for each engine (it is less expensive than installing a sync cable). If the port tachometer still shows port engine data, then one Gateway is enough.

The Device has a built-in Y-connector, and to connect the Device before the EVC tachometer, you only need to disconnect the tachometer cable, connect it to the Device, and connect the cable from the Device to the tachometer. If the engines are united on a network and there are multiple tachometers, you can choose any of them, whichever is most convenient.

Note that if you are installing the Gateway in the place of a broken EVC tachometer, the plug supplied with

the Device must be installed in the unused connector of Device. This plug connects the two CAN interfaces (CAN1 and CAN2, see Appendix E). The engine controller sends data on the CAN1 interface and monitors the echo on CAN2. CAN1 and CAN2 are joined in EVC tachometer. If the tachometer is not installed and the plug is not set, the engine controller will see no echo at CAN2 and will stop data transmission.

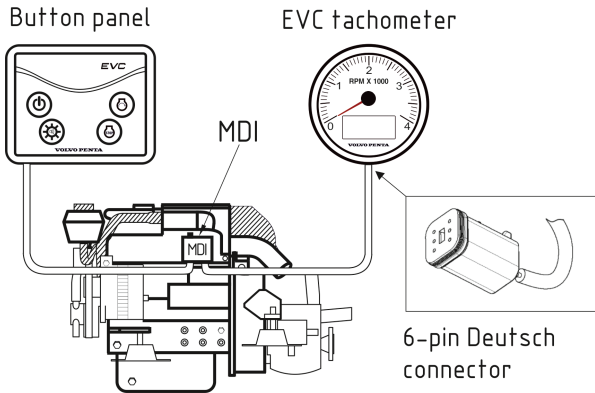

*Figure 2. Volvo Penta engine with MDI and EVC tachometer*

In case of connection to a free «Multilink» port of the HCU (not in series with any of the existing Multilink connections), setting of supplied plug is required. In case of connection to the free port of a Multilink hub, the plug is required only if no other EVC equipment is connected to the hub (if you are unsure, you can initially connect Device without the plug, and install the plug in case of failure).

Note that the plug (Deutsch connector of male type) cannot be installed if you are connecting the Gateway

to the HCU or a hub without an EVC cable, because the required Device connector (female) will be inserted in the HCU/hub. In this case you can contact us before ordering, and we'll supply you with a female type plug instead of the male type free of charge. You can also join the pins of the female Device connector yourself (CAN1 HIGH with CAN2 HIGH, CAN1 LOW with CAN2 LOW, see Appendix E). This situation is very rare in practice.

## IV.2 Connection to BRP Rotax Engines



*BRP CAN protocol differs from J1939 and Volvo Penta EVC protocols and requires configuration of the Device. BRP CAN diagnostics connector wiring is also different from the Device's engine connector wiring; you should change the pins in the connector or use an adaptor cable.*

The Device supports up to two BRP engines on a network. The following data are supported:

- engine speed;
- engine hours;
- engine temperature;
- boost pressure;
- keyswitch battery voltage;
- fuel rate;
- fuel tank level;
- engine warnings transmitted in J1939 messages with PGN 65226; native engine warnings (see Table 3 in VI.3)

To activate BRP CAN protocol support for most engines, you should add the following lines to the configuration file (see V.19 and V.20 for details):

```
BRP_ROTAX=ON  
ENGINE_CAN_SPEED=500
```

Please note that the Device must be rebooted before the new CAN bus speed comes into effect. Most BRP engines have 500 kbps CAN speed, but some models use 250 kbps. If you do not get any data, try to set 250 in the second parameter. If get RPM and engine hours, but no fuel rate and oil pressure, set the HANDSHAKE value to BRP\_ROTAX setting.

Usually, that is all that you need to do to change in the default settings.

Engines in a BRP CAN network have no J1939 addresses, but addresses are used in the Device's

settings to map engines to NMEA 2000 identifiers. The Device will save port engine data for the engine configured with J1939 address 0, and starboard engine data to the engine configured with J1939 address 1. If the data for the port and starboard engines are reversed on the chart plotter's screen, you must change the default settings to:

```
ENGINE_0=1  
ENGINE_1=0
```

Only one fuel tank is supported for BRP CAN in this version. The vessel's fuel tank level is transmitted to the NMEA 2000 fuel tank with the «0,PORT» setting. By default (with the setting FUEL\_0=0,PORT), the vessel's fuel tank will be displayed as the first fuel tank on NMEA 2000 gauges.

Note, you may set the fuel type for your tank (see V.5):

```
FUEL=GASOLINE
```

But many chart plotters cannot display gasoline tanks, so use DIESEL in case of compatibility issues.

Engine data are available at the diagnostics connector of BRP CAN, it can be located near a fuse box.

The BRP CAN diagnostics connector is the same 6-pin Deutsch connector as used in the Device, but the wiring is different (see the Appendix G). To physically connect the Device to the engine network, you should use an adaptor cable, available in accessories on the ordering page. Or you can disassemble the Device's connector and change the pin order.

## IV.3 Connection to J1939 Engines



*Adaptor cables for some J1939 engines (including Caterpillar and Yanmar) are available. Please, check our web site for current information.*

The Device works with engines and engine networks using the widespread J1939 standard, which at the physical level is a CAN bus with 250 kbps speed. J1939 is the standard for automobiles, heavy equipment, and industrial engines and generators.

With factory settings, the Device does not transfer data to the J1939 network (only from it), so proper installation of the Device will have no effect on the work of this network. However, you can configure settings VI.32 and VI.33 to forward data (like speed or course) from an NMEA 2000 to an engine's network if it is required for the trip computer or other equipment in the engine's network.

Connect the contacts (3) CAN1 HIGH and (1) CAN1 LOW from the Device (see Appendix E) to the CAN HIGH and CAN LOW signals of the J1939 network. The (4) and (6) contacts on the connector must have power coming in between 12V and 24V. The CAN2 HIGH contact (5) and CAN2 LOW (2) contact are not connected to the Device.

The connectors used in the Device are Deutsch DT04-6P and DT06-6S (see Appendix E), which can be obtained in any auto parts store or a specialized internet store, such as Mouser Electronics ([www.mouser.com](http://www.mouser.com)).

Please check the CAN and power lines as described at beginning of chapter IV.

## IV.4 Connection to SmartCraft Engines

The SmartCraft protocol is used in Mercury and MerCruiser engines, and differs from J1939 and Volvo Penta EVC protocols and requires configuration of the Device. The Gateway can be connected to a 10-pin SmartCraft connector with the adaptor Y-cable, available on our website.

The Device supports up to four SmartCraft engines on a network. A list of the supported data and warnings is available in Appendix H. Note that the number of NMEA 2000 engine warnings is limited and cannot cover all SmartCraft warning and error codes. To activate the SmartCraft protocol support, the V.35 setting must be set to ON (SMARTCRAFT=ON).

If you get a limited set of data in NMEA 2000, try to change the value of the SMARTCRAFT setting to HANDSHAKE (usually this is required on old engines with analog gauges).

Engines in a SmartCraft network has numbers from 0 to 3 and the transmission has no dedicated address. In the Gateway settings, engine numbers must be used instead of J1939 engine or transmission addresses. Each engine may have two fuel tanks (port and starboard).

The recommended configuration for a vessel with four engines, one battery and four fuel tanks connected to engine #0 (port) and engine #1 (centerline port) is:

```
SMARTCRAFT=ON
ENGINE_0=0
ENGINE_1=1
ENGINE_2=2
ENGINE_3=3
NMEA_ALTERNATOR=KEYSWITCH
TRANSMISSION_0=0
TRANSMISSION_1=1
TRANSMISSION_2=2
TRANSMISSION_3=3
FUEL_0=0, PORT
FUEL_1=0, STARBOARD
FUEL_2=1, PORT
```

FUEL\_3=1, STARBOARD  
BATTERY\_0=1  
BATTERY\_1=OFF  
TRIM\_ZERO=1800  
TRIM\_STEP=200

To calibrate electronic tilt/trim sensor, please, see V.37-39.



## V. Configuring the Device

To configure the Device, a text file with the configuration should be created and named YDEG.TXT in the root folder of the MicroSD card. A sample of the configuration file is in Appendix D.

The file contents must conform to these rules:

- parameters and their values must be entered in UPPER CASE;
- each parameter must be on its own line;
- commentary lines must start with the # symbol.

Insert the card with a configuration file into the Device and in a few seconds you will see three LED signals (see Section VII) indicating that the configuration file has been processed. A file YDEGSAVE.TXT will be created on the memory card with the current configuration of the Device. After the three LED signals, you can remove the card and check the new YDEGSAVE.TXT file to be sure that the configuration file has been properly interpreted.

You also can load an empty configuration file (zero length) into the Device to get the YDEGSAVE.TXT file with the full configuration of the Device and then use it as a template to configure the Device.

### 1. ENGINE\_x=y

*x* – identifier of an engine on the NMEA 2000 network [0..7]

*y* – address of the engine on the J1939 network [0..253,OFF]

*Factory configuration (from x=0 to 7): 0, 1, OFF, OFF, OFF, OFF, OFF, OFF*

Engines on the NMEA 2000 network have identifiers. The port engine (or the only engine on the vessel) has an identifier of 0; the identifier increase from port to starboard.

The engines on the J1939 network have addresses, with the port engine having the address of 0, and following engines having the address of 1 and so on. But this rule may not always be kept.

For example, a catamaran has 2 engines not connected by a single network, both engines will have an address of 0 on their separate J1939 networks. In this case, the following settings should be used:

Device connected  
to the port engine

ENGINE\_0=0  
ENGINE\_1=OFF

Device connected  
to the starboard engine

ENGINE\_0=OFF  
ENGINE\_1=0

The value OFF is guaranteed to prevent the transfer of data to the NMEA 2000 network for the given identifier.

Engines in the BRP CAN and SmartCraft networks have no J1939 addresses, but this setting is used to identify port and starboard engines. Please see IV.2 and IV.4 for details.

### 2. NMEA\_BATTERY= [KEYSWITCH | CHARGING | POWER\_INPUT | OFF]

*Factory setting: KEYSWITCH*

Equipment in the NMEA 2000 network can display data on the battery's voltage. In the NMEA 2000 network may already have sensors to detect the battery voltage. In this case, you can set the value of this parameter to OFF in order to exclude the transfer of information about the batteries' charge.

The engine can provide data about the ignition (keyswitch) battery voltage, voltage in the charging circuit, and the potential of an additional battery that is connected to the engine. With this option, you can specify that this data be transferred as information about the battery charge.

What information gets transferred by the engine and what the meaning of the data is depends on the engine's software and settings of the engine network. For example, a Volvo Penta D2-40F transfers only the ignition (keyswitch) battery information — other data is not available.

### 3. BATTERY\_x=y

*x* – identifier of the battery on the NMEA 2000 network [0..7]

*y* – the address of the engine or equipment on the J1939 network that provides the data on the battery potential [0..253,OFF].

*Factory settings (from x=0 to 7): 0, 1, OFF, OFF, OFF, OFF, OFF, OFF*

Batteries on the NMEA 2000 network have identifiers analogous to engines. The value, though, is not related to the location or purpose of the battery.

For example, on a sailing yacht with a single engine, data on the service battery will be transferred by a special sensor on the NMEA 2000 network. The service battery has an identifier of 0 on the NMEA 2000 network. The engine has an address of 0 on the J1939 network and provides data about the ignition (keyswitch) battery. Then the correct configuration file would look like this:

```
ENGINE_0=0
NMEA_BATTERY=KEYSWITCH
BATTERY_0=OFF
BATTERY_1=0
```

#### *4. NMEA\_ALTERNATOR=[KEYSWITCH | CHARGING | POWER\_INPUT | OFF]*

*Factory setting: KEYSWITCH*

Along with data about the current parameters of the engine's operation, the Device can provide data about the voltage potential of the alternator of the given engine. The possible values of the parameter are described in NMEA\_BATTERY. The data for the engine will be transferred only if the list of BATTERY\_x parameters contains a battery with the same J1939 address as the engine.

#### *5. FUEL=[DIESEL | GASOLINE | OFF]*

*Factory setting: DIESEL*

The OFF value completely blocks sending of data about the level of fuel in the tanks. The values DIESEL and GASOLINE are used when sending message about the level of fuel to specify the fuel type.

Note that many chart plotters cannot display gasoline tanks; use DIESEL as the value if there are compatibility issues.

## 6. FUEL\_x=[y,z|OFF]

*x* – identifier of the fuel tank on the NMEA 2000 network [0..9]

*y* – address of the engine (or other equipment) of the J1939 network, providing data on the level of fuel in the tank [0..254]

*z* – tank [PORT, STARBOARD]

Factory setting (from *x*=0 to 7): {0,PORT}, {0,STARBOARD}, OFF, OFF, OFF, OFF, OFF, OFF, OFF, OFF

The engine and other equipment on the J1939 network can send information about two fuel tanks which are nominally counted as the first and second, or left and right, port or starboard (J1939 SPN 96 or SPN 38).

Example of the configuration file:

```
FUEL=DIESEL
FUEL_0=0,PORT
FUEL_1=0,STARBOARD
FUEL_2=OFF
```

In the BRP CAN network, only one fuel tank is supported, its data is stored to the fuel tank with the «0,PORT» setting, see IV.2 for details.

In a SmartCraft network, two fuel tanks (port and starboard) can be connected to each engine. Use the engine number (0..3) instead of the address of the engine.

## 7. MDI\_PROP\_MESSAGE=[ON|OFF]

Factory setting: ON

Turns on processing of messages from the Volvo Penta MDI (Mechanical Diesel Interface, installed on engines D1 and D2) about the engine's status and warnings (see VI.1). These messages are proprietary Volvo Penta extension of J1939 standard.

## 8. MDI\_AUX\_MASK=x

*x* – 24-bit mask, hexadecimal number 000000...FFFFFF

*Factory setting:* 000000

This parameter controls mapping of the signal of auxiliary sensor of the Volvo Penta MDI (AUX, see VI.1) to the engine's status in the NMEA 2000 network. For example, if an auxiliary sensor is installed and signals that there is water in the fuel, set the value of the mask in 000100 (hexadecimal number, bit 9 is set) in accordance with the table in Appendix B. See also MDI\_PROP\_MESSAGE.

## 9. MDI\_SYS\_FAULT\_MASK=x

*x* – 24-bit mask, hexadecimal number 000000...FFFFFF

*Factory setting:* 000000

Displays the «System fault» status of the Volvo Penta MDI block (see VI.1) on the status of the engine on the NMEA 2000 network. See also the description of MDI\_AUX\_MASK and MDI\_PROP\_MESSAGE.

## 10. ALERT\_x=[y,w,z|OFF]

*x* – digit from 0 to 9, internal index of the Device

*y* – 24-bit mask, hexadecimal number 000000...FFFFFF

*w* – decimal number of SPN, see the manual of your specific engine

*z* – decimal number FMI, from 0 to 31, see the manual of your engine

When a diagnostic message (PGN 65226) with specified SPN and FMI codes is received from the engine, set the bits of the engine status in NMEA 2000 to according to the mask. For example:

```
ALERT_0=000020,158,1
```

Set the sixth bit (hexadecimal 000020) in the engine status (see Appendix B), indicating «Low System Voltage», when a diagnostic message received with the SPN and FMI equal to 158 and 1, respectively.

11. *ALERT\_WARN1\_MASK=x*

*x* – 24-bit mask, hexadecimal mask, hexadecimal number 000000...FFFFFF

*Factory setting: 000000*

Set bit 17 of the engine status («Warning Level 1») if at least one bit of the current engine status matches the specified mask. Use of this setting is described in VI.5.

12. *ALERT\_WARN2\_MASK=x*

*x* – 24-bit mask, hexadecimal number 000000...FFFFFF

*Factory setting: 000000*

Set bit 18 of the engine status («Warning Level 2») if at least one bit of the current engine status matches the specified mask. Use of this setting is described in VI.5.

13. *ALERT\_POWER\_REDUCTION\_MASK=x*

*x* – 24-bit mask, hexadecimal number 000000...FFFFFF

*Factory setting: 000000*

Set bit 19 of the engine status («Power Reduction») if at least one bit of the current engine status matches the specified mask. Use of this setting is described in VI.5.

14. *NMEA\_ALERT\_MASK=x*

*x* – 24-bit mask, hexadecimal number 000000...FFFFFF

*Factory setting: FFFFFFF*

Only bits set in this mask can be set by the Device in the engine status in NMEA 2000. Use of this parameter is described in Section VI.6. See V.30 also.

### 15. TRANSMISSION\_x=y

*x* – identifier of a transmission on the NMEA 2000 network [0..7]

*y* – address of the transmission on the J1939 network [0..253, OFF]

Factory configuration (from *x*= 0 to 7): 3,4,OFF,OFF,OFF,OFF,OFF,OFF

Like a port engine (see V.1), port transmission has an identifier 0 in NMEA 2000; the identifier increase from port to starboard. The value OFF is guaranteed to prevent the transfer of data (current gear, oil temperature and pressure) to the NMEA 2000 for the given identifier. See V.30 also.

For SmartCraft network, engine number (0..3) should be used instead of transmission address.

### 16. TANK\_CAPACITY\_x=y|DEFAULT

*x* – fuel tank number

*y* – volume in liters

Fuel level data are transmitted in the engine network as a percentage. Use this setting to specify the volume of fuel tank. If this value is set, volume will be transmitted together with the fuel level in percent to the NMEA 2000 network. The DEFAULT value prohibits transmission of the tank volume.

### 17. TANK\_CALIBRATION\_x=p4,p8,...,p95|OFF

*x* – fuel tank number

p4,p8,...,p95 – 12 calibration points (decimal values, 0..100)

Factory setting: OFF for all tanks

Resistive fuel level sensors cannot take into account the shape of the fuel tank, and the readings usually have substantial error. This setting defines 12 calibration points for 4, 8, 12, 20, 30, 40, 50, 60, 70, 80, 90 and 95% readings (assuming that 0% and 100% readings do not require calibration). For each point, you should specify the correct reading value. For example, if your fuel gauge shows 50% when the tank actually is only 19% full, then you should set 19 as the value for the 50% calibration point (7th value in the calibration string).

To simplify obtaining the calibration string, we prepared an Excel file available on our web site. You only need to specify your gauge's readings and the measured remaining fuel volume to get the calculated calibration string.

*18. EXHAUST\_TEMP=ON|OFF*

*Factory setting: ON*

Allows or denies transmission of exhaust gas temperature. Legacy chart plotters may not show this data.

*19. BRP\_ROTAX=ON|OFF|HANDSHAKE*

*Factory setting: OFF*

Turn on/off the support of BRP CAN protocol, used in Bombardier Recreational Products engines, e.g. Rotax 1503. The HANDSHAKE setting may help with some old engines if fuel rate and some other data are not available. Note that most BRP engines use 500 kbps CAN speed and some engines use 250 kbps speed (see the next setting).

*20. ENGINE\_CAN\_SPEED=50|125|250|500*

*Factory setting: 250*

Switch the speed of engine network interface between 250 kbps (default setting used in Volvo Penta EVC, SmartCraft and J1939 engines), 500 kbps (used in most of BRP CAN engines), 50 and 125 kbps (experimental, no practical application). Note that the device must be rebooted for the change to take effect.

*21. VOLCANO=ON|OFF*

*Factory setting: OFF*

This setting is required on Gateways connected to the C4:MULTISENSOR (yellow) or C5:ENGINE (grey) ports of an EVC-A MC (EVCmc) system only. Please see IV.1.4 for details.



## 22. WATER\_DEPTH\_OFFSET=x

*x – OFF (default value) or a number from -1000 to 1000*

Positive numbers (in centimeters) represent the distance from the transducer to the water line and negative values represent the distance from the transducer to the keel. This value is sent as the transducer offset (in separate data field) of the «Water Depth» message in NMEA 2000.

The OFF value turns off sending of the «Water Depth» message. This setting is used on Devices connected to the C4:MULTISENSOR port of an EVC-A MC (EVCmc) system only (see IV.1.4), setting V.21 must be set to ON.

## 23. WATER\_SPEED\_CORRECTION=x

*x – OFF (default value) or a number from -1000 to 1000*

Numbers indicate speed correction factor in percent (10 is +10%). Speed is sent in the «Speed, Water Referenced» message of NMEA 2000.

The OFF value turns off sending of the «Speed, Water Referenced» message. This setting is used on Devices connected to the C4:MULTISENSOR port of an EVC-A MC (EVCmc) system only (see IV.1.4), setting V.21 must be set to ON.

## 24. WATER\_TEMP\_OFFSET=x

*x – OFF (default value) or a number from -1000 to 1000*

Numbers are in 0.1 Celsius, -10 means that readings will be decreased by 1 degree Celsius. Temperature is sent as sea temperature in the «Temperature, Extended Range» message of NMEA 2000.

The OFF value turns off the sending of «Temperature, Extended Range» messages. This setting is used on Devices connected to the C4:MULTISENSOR port of an EVC-A MC (EVCmc) system only (see IV.1.4), setting V.21 must be set to ON.

## 25. INTAKE\_MANIFOLD\_TEMP=*x*

*x* – OFF (default value) or a number from 1 to 252

NMEA 2000 has no data type for transmitting intake manifold temperature (supported in Volvo Penta, J1939, SmartCraft and BRP Rotax engines). Moreover, many chart plotters have gauges for a limited set of data types.

This setting is added to work around these limitations. OFF blocks the sending of temperature messages, and values 1 to 252 cause sending of «Temperature, Extended Range» NMEA 2000 messages with the temperature of following data type:

- 01 = Outside Temperature
- 02 = Inside Temperature
- 03 = Engine Room Temperature
- 04 = Main Cabin Temperature
- 05 = Live Well Temperature
- 06 = Bait Well Temperature
- 07 = Refrigeration Temperature
- 08 = Heating System Temperature
- 09 = Dew Point Temperature
- 10 = Wind Chill Temperature, Apparent
- 11 = Wind Chill Temperature, Theoretical
- 12 = Heat Index Temperature
- 13 = Freezer Temperature
- 14 = Exhaust Gas Temperature
- 15 through 128 Reserved
- 129 through 252 Generic Temperature Sources other than those defined

Therefore, you can map intake manifold temperature to one of the temperature gauges supported by your NMEA 2000 displays.

## 26. EDC2=*x*

*x* – OFF (default value) or ON

Turn on or off experimental support of EDC II. Volvo Penta engines with EDC II use a J1939 interface for engine synchronization only. This means that the port engine sends actual revolutions, and the starboard engine listens and synchronizes revolutions. Unfortunately, other data are not present on the J1939 interface. You can connect YDEG to a sync cable (yellow/white is CAN HIGH, yellow/grey is CAN LOW) and even «emulate» twin engines for chart plotters:

```
EDC2=ON
ENGINE_0=0
ENGINE_1=0
```

With the above settings, you can see two engines on your chart plotter, but actually both RPM gauges will show port engine data. Please, see setting V.29 to learn more about EDC II engines support.

## 27. PASS\_PGN=*x*

*x* – empty or list NMEA 2000 or J1939 PGNs separated by comma

Factory setting: empty

Forward specified messages from an engine network to a NMEA 2000 network (see also V.32-33). Many motorboats have NMEA 2000 transducers installed in an engine network, and YDEG allows forwarding of this data and display on the chart plotter (see the next setting also).

To forward water depth (NMEA 2000 PGN 128267), speed through water (PGN 128259), and water temperature (PGN 130310), add the following line to the YDEG.TXT file (up to 20 PGNs can be specified):

```
PASS_PGN=128267,128259,130310
```

## 28. PASS\_ADDR=OFF|YDEG|AS\_IS|*n*

*n* – number from 0 to 253

*Factory setting: OFF*

Different devices in engine and NMEA 2000 networks can have matching addresses. And forwarding of such messages can cause conflicts. To avoid conflicts, YDEG can use its own, original address or a specified address as the sender address in the forwarded messages. This is managed by the PASS\_ADDR setting.

OFF value turns off the forwarding of messages, with AS\_IS messages being forwarded as is (with original sender address). If the YDEG value is chosen, the address of Gateway will be used, or you can set a fixed address in a range of 0 – 253.

The YDEG value is a recommended option in the case of forwarding NMEA 2000 messages. The AS\_IS option should be used to forward J1939 messages. For example, to forward active diagnostic trouble codes from one or multiple engines:

```
PASS_PGN=65226  
PASS_ADDR=AS_IS
```

### *29. SETTING GROUP STARTING WITH J1708*

These settings were available in firmware versions up to 1.22 and designed for our experimental J1708/J1587 adaptor. If you have this adapter, contact us for the latest firmware and manual. Please use J1708 Engine Gateway YDES-04 for Volvo Penta engines equipped with EDC I and EDC II (KAD, TAMD) and engines with a J1708/J1587 interface.

### *30. TRANMISSION\_ALERT\_MASK=x*

*x – 5-bit mask, hexadecimal number 00...1F*

*Factory setting: 1F*

Only bits set in this mask can be set by the Device in the transmission status in NMEA 2000. Use of this parameter is described in Section VI.6.

### 31. *HOURS\_OFFSET=x*

*x* - number of seconds, 0..10000000

*Factory setting: 0*

The number of seconds which are added to engine hours. Some users have replaced ECU and EDC modules, which reports engine hours since installation of module. This setting helps to get real data on gauges.

### 32. *J\_PASS\_PGN=x*

*x* – empty or list of NMEA 2000 or J1939 PGNs separated by comma

*Factory setting: empty*

Forward specified messages from an NMEA 2000 network to an engine network. Some boats have trip/fuel computers installed in the engine network that require NMEA 2000 speed data.

To forward speed through water (PGN 128259) and speed over ground with course (PGN 129026), add the following line to the YDEG.TXT file (up to 20 PGNs can be specified):

```
J_PASS_PGN=128259,129026
```

### 33. *J\_PASS\_ADDR=OFF|AS\_IS|n*

*n* – number from 0 to 253

*Factory setting: 210*

The network address is used to send messages to the engine's network. Addresses below 180 can be occupied by various devices. The OFF value turns off the forwarding of messages, with AS\_IS messages being forwarded as is (with the original sender address).

It is recommended to keep the factory setting if you have no reasons to change it.

### 34. *TRANS\_ALERT\_x=[y,w,z|OFF]*

*x* – digit from 0 to 9, internal index of the Device

*y* – 5-bit mask, hexadecimal number 00...1F

*w* – decimal number of SPN, see the manual of your specific engine

*z* – decimal number FMI, from 0 to 31, see the manual of your engine

When a diagnostic message (PGN 65226) with specified SPN and FMI codes is received from the engine's transmission, set the bits of the transmission status in NMEA 2000 according to the mask. For example:

```
TRANS_ALERT_0=08,124,18
```

Set the fourth bit (hexadecimal 08) in the transmission status (see Appendix B, Table 2), indicating «Low Oil Level», when a diagnostic message received with the SPN and FMI equal to 124 and 18, respectively.

### 35. *SMARTCRAFT=ON|OFF|HANDSHAKE*

*Factory setting: OFF*

Activates SmartCraft protocol support used in Mercury and MerCruiser engines (see IV.4 for details).

Use the HANDSHAKE value if you have a limited set of data (the RPM only) in NMEA 2000 (required for some old engines with analog gauges). Switch between on and off resets tilt/trim calibration (see V.37-39) to default values for the selected system.

### 36. *MEFI4B=ON|OFF*

*Factory setting: OFF*

This settings turns on use of proprietary Volvo Penta messages with tilt/trim data available in MEFI 4B only. Switching between on and off resets tilt/trim calibration (see V.37-39) to values for selected system.

### 37. TRIM\_ZERO=*x*

*x* – calibration value of 0% tilt/trim position, 0..65534

Factory setting: 28708

The Gateway process three different messages with tilt/trim data depending on the current settings. Switching on/off SMARTCRAFT or MEFI4B setting (V.35-36) resets the value to default for SmartCraft, MEFI or Volvo Penta EVC systems. This value corresponds to zero tilt/trim angle of the engine. See V.39.

### 38. TRIM\_STEP=*x*

*x* – calibration value of 1% step of tilt/trim, -30000..30000 (except 0)

Factory setting: 128

The Gateway process three different messages with tilt/trim data depending on the current settings. Switching on/off SMARTCRAFT or MEFI4B setting (V.35-36) resets the value to default for SmartCraft, MEFI or Volvo Penta EVC systems. This value corresponds to a 1% step of tilt/trim angle of the engine. See V.39.

### 39. CALIBRATE\_TRIM=*x*

*x* – current tilt/trim of the port engine (ENGINE\_0), from -100 to 100 (in percent)

Factory setting: not applied

This setting is not saved to the configuration or to the YDEGSAVE.TXT file; it is used to specify the current tilt/trim angle of the port engine (ENGINE\_0) to update V.38-V.39 settings with actual data.

Negative trim angle is not supported by most MFDs, and it is recommended to calibrate the tilt/trim to a range of 0..100%. To begin, set the port engine to the lowest position, and load the configuration file with the single line:

```
CALIBRATE_TRIM=0
```

If the Gateway actually has tilt/trim data, the value of TRIM\_ZERO setting (V.37) will be updated and you will see 3 green confirmation flashes. Then lift the engine to highest position and load the file with the line:

```
CALIBRATE_TRIM=100
```

The Gateway will calculate trim step corresponding to 1% and update the TRIM\_STEP value (V.38). Review V.37-38 settings in the YDEGSAVE.TXT and modify values if required.

#### *40. GROUP OF SETTINGS: SUBSTITUTE\_xxxx=OFF|y*

*xxxx* — BOOST, FUEL\_PRESSURE, OIL\_PRESSURE, OIL\_TEMP, CLNT\_PRESSURE, CLNT\_TEMP, TRANS\_PRESSURE, TRANS\_TEMP

*y* — sensor data instance, decimal number from 0 to 252

*Factory setting: all settings are OFF*

This group of settings allows replacing of engine data with data from NMEA 2000 sensors connected to NMEA 2000 network or engine network. Temperature data (engine oil, coolant, transmission oil) are replaced by data from temperature sensors (PGN 130312 or 130316); pressure data (boost, fuel, engine oil, coolant or transmission oil pressure) are replaced by data from pressure sensors (PGN 130314).

The data instance of the sensor (do not confuse with NMEA 2000 device or system instance, or with data type like «Air Temperature» or «Sea Temperature») should match with the specified data instance in the setting, these data will be used for the port engine (ENGINE\_0 or TRANSMISSION\_0, see V.1 and V.15). For the next engine/transmission (ENGINE\_1 or TRANSMISSION\_1), the data from the sensor with the next number will be used.

For example:

```
SUBSTITUTE_BOOST=3
```

In the case of twin engines, the sensor with data instance 3 will be used as the boost pressure source for the port engine, and the one with instance 4 (next number) will be used for the starboard engine. These settings turn on substitution of the data for all engines or transmissions. It is not possible, for example, to substitute boost data for the port engine and leave the original boost engine data for the starboard engine.



For temperature data types, we recommend using Exhaust Gas Sensor YDGS-01. This measures temperatures up to 800 Celsius. The data instance can be configured with a YD:DAT command. For pressure data types, we recommend Tank Adapter YDTA-01. This product is an NMEA 2000 adapter for resistive and voltage sensors, and can work in parallel with analog and digital gauges. Initially designed as a fuel level sensor, it has a setting to «convert» it to a pressure sensor.

## VI. Display Engine and Transmission Status (Warnings)





The standard NMEA 2000 defines 24 warnings for engine status and 5 for transmission status that are listed in Appendix B. The NMEA 2000 displays and chart plotters can support display of the engine status in different varying degrees.





### 1. Volvo Penta D1 and D2 engines

The low-power engines for sailing yachts, Volvo Penta series D1 and D2, are equipped with electronic control block MDI (Mechanical Diesel Interface) and have a few sensors connected to the MDI which report on a small number of problems: engine overheating, low oil pressure, and low ignition battery voltage.

The MDI block, unlike electronic blocks of other engines, provides data about the condition with a proprietary message. To process these messages, the parameter MDI\_PROP\_MESSAGE must be set to ON (see V.7).

Table 1. Display of engine status for D1 and D2 engines in NMEA 2000

Symbol	Description	Status in NMEA 2000 [bit]
	<b>Pre-heating.</b>	Preheat Indicator [11].
	<b>Starting.</b> Turning on the starter	Not displayed, no corresponding status.
	<b>Stopping.</b> Engine stopping	Engine Shutting Down [24].
	<b>Fuel level.</b> Fuel level less than 20% (if sensor is installed).	Not displayed, no corresponding status.

Symbol	Description	Status in NMEA 2000 [bit]
	<b>System fault.</b> Malfunction in engine cables (open circuit, short circuit).	Can be mapped by user (*).
<b>AUX</b>	<b>Auxiliary alarm.</b> Triggering of auxiliary sensor (if connected; depending on the implementation).	Can be mapped by user (*).
	<b>Coolant temperature.</b> High temperature of coolant.	Over Temperature [2].
	<b>Oil pressure.</b> Low oil pressure.	Low Oil Pressure [3].
	<b>Charging.</b> Low voltage of ignition battery.	Low System Voltage [6].

- \* The conditions «System fault» and «Auxiliary alarm» can be mapped by the user to bits of engine status in NMEA 2000 using the settings:MDI\_AUX\_MASK and MDI\_SYS\_FAULT\_MASK (see V.8 and V.9)

## 2. Other Volvo Penta and J1939 engines

Modern engines can have more than 10 different sensors and provide hundreds of diagnostic codes (in J1939 messages with PGN 65226). Generally used diagnostic codes are described in the J1939 standards.

Table 2. Display of J1939 engine and transmission status

<b>Description</b>	<b>SPN</b>	<b>FMI</b>	<b>Engine status display in NMEA 2000 [bit]</b>
Low fuel pressure	94	1, 18	Low Fuel Pressure [5]
Water in fuel	97	0	Water in Fuel [9]
Low engine oil level	98	1	Low Oil Level [4]
Low engine oil pressure	100	1, 18	Low Oil Pressure [3]
High boost pressure	102, 106	0, 16	High Boost Pressure [12]
High coolant temperature	110	0, 16	Over Temperature [2]
Low coolant level	111	1	Low Coolant Level [7]
Low battery voltage	158	1	Low System Voltage [6]
Engine over speed	190	0, 16	Rev Limit Exceeded [13]
High oil temperature (transmission)	177	0,16	Transmission Over Temperature [2]
Low oil pressure (transmission)	127	1,18	Transmission Low Oil Pressure [3]
Low oil level (transmission)	124	1	Transmission Low Oil Level [4]

With the ALERT\_x and TRANS\_ALERT\_x parameters, you can independently display up to 10 diagnostic codes on engine and transmission status bits in NMEA 2000 (see V.10 and V.34).

### 3. Bombardier BRP Engines

The Engine Gateway supports native fault codes of BRP engines in addition to fault and diagnostics codes transmitted with J1939 DM1 messages (see Table 2 above).

Table 3. Supported BRP CAN fault codes

<b>Fault Code</b>	<b>Fault Description</b>	<b>NMEA 2000 Status</b>
P0217	High engine coolant temperature	Over Temperature [2]
P0524	Low oil pressure condition	Low Oil Pressure [3]
P1520	Low oil level	Low Oil Level [4]
P0562	Battery voltage too low	Low System Voltage [6]
P0127	Intercooler system fault	Water Flow [8]
P0544	Exhaust gas temperature sensor functional problem	EGR System [14]
P0545	Exhaust gas temperature sensor shorted to ground	EGR System [14]
P0546	Exhaust gas temperature sensor open circuit or shorted to battery	EGR System [14]
P0122	TAS (Throttle Accelerator Sensor) 1 fault (short circuit to GND)	Throttle Position Sensor [15]
P0123	TAS (Throttle Accelerator Sensor) 1 fault (short circuit to battery)	Throttle Position Sensor [15]
P1102	TPS adaption failure	Throttle Position Sensor [15]
P1104	TPS adaption cancelled	Throttle Position Sensor [15]
P0600	CAN communication problem	Engine Comm Error [21]
P1680	Communication problem detected by MPEM	Engine Comm Error [21]
P1681	Communication problem – instrument cluster message missing	Engine Comm Error [21]
P1682	Communication problem – EMS message missing	Engine Comm Error [21]

Not all BRP CAN fault codes can be mapped to a NMEA 2000 engine status, because NMEA has only 24 engine status flags (see Appendix B). But you can define mapping of additional fault codes with the ALERT\_x setting (see V.10).

For example, to map P1030 to «Maintenance Needed», you should place the following line in the configuration file:

```
ALERT_0=080000,4144,0
```

Where 080000 is the hex mask of «Maintenance Needed» (see Appendix B), 4144 is a decimal equivalent of hexadecimal 1030 (BRP fault codes are hexadecimals), the last number — 0 — can be any value from 0 to 31 (not used).

#### *4. SmartCraft warnings*

A list of supported warnings and errors is available in the Appendix H.

#### *5. Combination warnings*

Engine status bits in NMEA 2000 like «Warning Level 1», «Warning Level 2», and «Power Reduction» are combination warnings. Non-critical issues like low battery voltage or water in the fuel filter can initiate second-level general warnings, and engine over-heating or low oil pressure are first-level warnings. Display or indicating devices can display these statuses with yellow or red lights, respectively.

Using the ALERT\_WARN1\_MASK, ALERT\_WARN2\_MASK and ALERT\_POWER\_REDUCTION\_MASK (see V.11-V.13), you can configure how these statuses are turned on.

For example, to have the «Warning Level 2» status turn on when water is in the fuel filter (bit 9) or when there is low system voltage (bit 6), you should assign the following mask (assigned in hexadecimal values):  
ALERT\_WARN2\_MASK=000120

#### *6. Global blocking of warnings*

The NMEA\_ALERT\_MASK (see V.14) parameter is assigns the mask for status bits applied before sending the message. Accordingly, to allow all warnings, set its value to FFFFFFFF (assigned as a hexadecimal number), to prevent all warnings from coming through, set it to 000000.

The TRANSMISSION\_ALERT\_MASK (see V.30) is used in the same way to block transmission warnings.

## VII. LED Signals

### *1. Signal with period of 5 seconds, two flashes of the LED.*

The first flash indicates the condition of the engine network. Green if within the last period (5 seconds) data has been accepted from the engine network, red if not.

The second flash indicates the condition of the NMEA 2000 network. Green if in the last period there has been data received or successfully sent (confirmation of data reception from other devices), red if not.

The Device accepts a limited set of NMEA 2000 messages (see Table 2, Appendix C), the remaining messages are filtered at the hardware level. In this regard, some NMEA 2000 networks can indicate a red light much of the time, when the engine network is turned off (ignition off) and the NMEA 2000 is functioning normally. In this case, to check the connection to the NMEA 2000 network turn one device that is on the network (e.g. the chart plotter) off and on again. The status of the NMEA 2000 for some time will be displayed with green flashes.

### *2. Three flashes, one time after inserting the MicroSD card into the Device*

Three green flashes: the YDEG.TXT file has been read and changes have been made to the current Device settings. The YDEGSAVE.TXT file on the card has been saved with the updated configuration.

Green, red, red: the YDEG.TXT file has been read from the card, but the current configuration of the Device has not been changed (either the configuration file does not differ from the current settings or there are no settings in the file). The YDEGSAVE.TXT file on the card has been saved with the current configuration.

Three red flashes: the YDEG.TXT was not found on the MicroSD card or the file system is not supported.

### *3. Five green flashes when NMEA 2000 network is turned on*

The Device has the MicroSD inserted with a firmware update, the firmware is updated (see Section VIII).

## VIII. Firmware Updates

In the root folder of the MicroSD card with FAT or FAT32 file system, copy GUPDATE.BIN, which contains the firmware update of the Device. Insert the card into the Device and turn on the power in the NMEA 2000 network.

From 5-15 seconds after powering on, the LED will flash 5 times with green light. This indicates that the firmware update is successfully completed.

If the Device already is using the given version of the firmware, or if the Device cannot open the file or the file is corrupted, the boot loader immediately transfers control to the main program. This is done without visual cues.

The Device information including the firmware version is displayed in the list of NMEA 2000 devices (SeaTalk NG, SimNet, Furuno CAN) or in the common list of external devices on the chart plotter (see third line at Figure 1 on the next page). Usually, access to this list is in the Diagnostics, External Interfaces or External devices menu of the chart plotter.



Raymarine

Share icon

Mobile icon

Diagnostics

Select Device

Press to show diagnostic data for all devices: **Show All Data**

Device	Serial No	Network	Software
Digital Radome	E92129 0240451	SeaTalkHS	1.04
Raymarine p70 Display	0140299	STng	2.12
YDEG-04	00030042	STng	1.0 09/08/2016
i50 Tridata Instrument	0130213	STng	1.06
E22158-SeaTalk-STNG-Converter	1034742	STng	1.21
YDBC-05	00005027	STng	1.2 27/02/2015
Raymarine EV-1 Course Computer	0240651	STng	1.01 (RSCP V1 L4)

Standby Radar Tx Sonar GPS Fix

*Figure 1. Raymarine c125 MFD devices list with Gateway (YDEG-04)*

## IX. Recording Data and Diagnostics of the Engine Interface

The Device allows data to be recorded from the engine network to the MicroSD card for the purpose of diagnostics and configuration.

Turn the engine ignition off. Create a file called YDEG.TXT with the following line included:

```
ENGINE_LOG=ON
```

Note that the given configuration is not saved in the non-volatile memory and will stop its action after the card is removed or when the NMEA 2000 network is powered off.

Insert the MicroSD card into the Device and turn on the engine ignition. The Device will start recording data to the MicroSD card and create a file in the root folder with the name YDEGxxx.CAN, where xxx – is a file number. The Device starts recording to a new file each time the power to the engine network is turned on.

When the ignition is turned off (power in the engine network), the Device closes the file. Turn off the ignition and wait for the status of the engine network to change – to be displayed by a red signal by the LED (see VII.1). After this, the memory card can be safely removed from the Device.

To view, convert or export .CAN files, you may use the free CAN Log Viewer program, which works on Microsoft Windows, Mac OS X and Linux: [http://www.yachtd.com/products/can\\_view.html](http://www.yachtd.com/products/can_view.html)

The file format is open and described in the CAN Log Viewer documentation. To analyze data, protocol knowledge is required. BRP CAN is a proprietary protocol, Volvo Penta EVC protocol is a proprietary extension of J1939 protocol. J1939 protocol documentation can be obtained from SAE (<http://www.sae.org>).

## Appendix A. Troubleshooting

Situation	Possible cause and correction
The LED does not signal after the NMEA 2000 network is powered on	<p><b>1. No power supply on the bus.</b> Check if the bus power is supplied (NMEA 2000 network requires a separate power connection and cannot be powered by a plotter or another device connected to the network).</p> <p><b>2. Loose connection in the power supply circuit.</b> Treat the Device connector with a spray for cleaning electrical contacts. Plug the Device into another connector.</p>
The Device LED flashes every five seconds, but the Device is not displayed in the list of external devices on the plotter, data do not appear, the state of NMEA 2000 network always is «red»	<p><b>1. Loose connection in the data circuit.</b> Treat the Device connector with a spray for cleaning electrical contacts. Plug the Device into another connector.</p> <p><b>2. There are problems in the NMEA 2000 network.</b> The network segment is not connected to the plotter or there are missing terminators in the network. Plug another device into the selected connector and make sure it appears in the list of devices on the plotter. Note: please see VIII and VII.1 also.</p>
Ignition on, but the engine network status displays a red flashing light, data about the activity of the engine is not coming to the chart plotter	<p><b>1. Improper connector selected.</b> Make sure that the engine connector of the Device is connected to a right connector. To check the connector with a multimeter see V.</p> <p><b>2. No connection between CAN<sub>1</sub> and CAN<sub>2</sub>.</b> If you connected the Device to a free connector or, instead of an existing device in a Volvo Penta EVC network, install the plug supplied with Device into a free Device's connector.</p> <p><b>3. Invalid interface speed selected.</b> Volvo Penta EVC and J1939 networks use a speed of 250 kbps (used by default), BRP CAN networks use 500 kbps. See V.20.</p>

<b>Situation</b>	<b>Possible cause and correction</b>
Memory card with YDEG.TXT file is inserted into the Device, but three red lights are flashing.	<ol style="list-style-type: none"><li data-bbox="362 142 993 163"><b>1. Card is not formatted correctly.</b> Reformat card (see II.).</li><li data-bbox="362 179 1111 231"><b>2. Card contains logic error.</b> It is possible for such errors to go unnoticed by scanning utilities, recommendation to reformat card.</li><li data-bbox="362 246 1111 350"><b>3. File has wrong extension.</b> Some text editors adds .TXT extension to all created files, and files are saved as YDEG.TXT can actually end up with a name like YDEG.TXT.TXT. Please refer your operation system manual how to check and edit file extension.</li></ol>

## Appendix B. Bits for Engine and Transmission Status

Table 1. Bits for NMEA 2000 Engine Status (DD206, DD223)

Bit number	Mask (hex)	Meaning
1	000001	Check Engine
2	000002	Over Temperature
3	000004	Low Oil Pressure
4	000008	Low Oil Level
5	000010	Low Fuel Pressure
6	000020	Low System Voltage
7	000040	Low Coolant Level
8	000080	Water Flow
9	000100	Water in Fuel
10	000200	Charge Indicator
11	000400	Preheat Indicator
12	000800	High Boost Pressure
13	001000	Rev Limit Exceeded
14	002000	EGR System
15	004000	Throttle Position Sensor
16	008000	Engine Emergency Stop Mode
17	010000	Warning Level 1
18	020000	Warning Level 2
19	040000	Power Reduction
20	080000	Maintenance Needed
21	100000	Engine Comm Error
22	200000	Sub or Secondary Throttle
23	400000	Neutral Start Protect
24	800000	Engine Shutting Down

Table 2. Bits for NMEA 2000 Transmission Discrete Status (DD221)

Bit number	Mask (hex)	Meaning
1	01	Check Transmission
2	02	Over Temperature
3	04	Low Oil Pressure
4	08	Low Oil Level
5	10	Sail Drive

## Appendix C. NMEA 2000 and J1939 Messages Supported by the Device

Table 1. Supported J1939 messages

<b>PGN</b>	<b>SPN</b>	<b>Description</b>
60160	—	Transport Protocol — Data Transfer
60416	—	Transport Protocol — Connection Mgmt
61443	92	Electronic Engine Controller 2 / Engine Percent Load At Current Speed
61444	190	Electronic Engine Controller 1 / Engine Speed
61444	513	Electronic Engine Controller 1 / Actual Engine - Percent Torque
61445	523	Electronic Transmission Controller 2 / Current Gear
65226	—	Active Diagnostic Trouble Codes
65253	247	Engine Hours, Revolutions / Engine Total Hours of Operation
65262	110	Engine Temperature 1 / Engine Coolant Temperature
65262	175	Engine Temperature 1 / Engine Oil Temperature 1
65263	94	Engine Fluid Level/Pressure 1 / Engine Fuel Delivery Pressure
65263	100	Engine Fluid Level/Pressure 1 / Engine Oil Pressure
65262	109	Engine Fluid Level/Pressure 1 / Engine Coolant Pressure
65266	183	Fuel Economy (Liquid) / Engine Fuel Rate
65270	102	Inlet/Exhaust Conditions 1 / Engine Intake Manifold #1 Pressure
65270	173	Inlet / Exhaust Conditions 1 / Exhaust Gas Temperature
65271	158	Vehicle Electrical Power 1 / Keyswitch Battery Potential

Table 1 continued

<b>PGN</b>	<b>SPN</b>	<b>Description</b>
65271	167	Vehicle Electrical Power 1 / Charging System Potential (Voltage)
65271	115	Vehicle Electrical Power 1 / Alternator Current
65271	168	Vehicle Electrical Power 1 / Battery Potential / Power Input 1
65271	114	Vehicle Electrical Power 1 / Net Battery Current
65272	127	Transmission Fluids / Transmission Oil Pressure
65272	177	Transmission Fluids / Transmission Oil Temperature
65276	38	Dash Display / Fuel Level 2
65276	96	Dash Display / Fuel Level 1
65279	97	Water in Fuel Indicator
65373	—	Volvo Penta proprietary (engine tilt/trim)
65417	—	Volvo Penta proprietary (MDI warnings)



Table 2. Supported NMEA 2000 messages

<b>PGN</b>	<b>Tx</b>	<b>Rx</b>	<b>Description</b>
59392	Yes	Yes	ISO Acknowledgment
59904	—	Yes	ISO Request
60160	—	Yes	ISO Transport Protocol (DT)
60416	—	Yes	ISO Transport Protocol (CM)
60928	Yes	Yes	ISO Address Claim
65240	—	Yes	ISO Commanded Address
126208	Yes	Yes	NMEA Group Function
126464	Yes	—	PGNs Group List
126993	Yes	—	Heartbeat
126996	Yes	—	Product Information
126993	Yes	—	Heartbeat
126998	Yes	—	Configuration Information
127488	Yes	—	Engine Parameters, Rapid Update
127489	Yes	—	Engine Parameters, Dynamic
127493	Yes	—	Transmission Parameters, Dynamic
127505	Yes	—	Fluid Level
127508	Yes	—	Battery Status
128259	Yes	—	Speed, Water Referenced (see V.23)
128267	Yes	—	Water Depth (see V.22)

<b>PGN</b>	<b>Tx</b>	<b>Rx</b>	<b>Description</b>
130312	—	Yes	Temperature
130314	—	Yes	Actual Pressure
130316	Yes	Yes	Temperature, Extended Range

*Note: NMEA 2000 Device Instance, System Instance, Installation Description Field 1 and Installation Description Field 2 can be changed with PGN 126208 (a professional NMEA 2000 installer software and hardware may be required). Yacht Devices Engine Gateway YDEG-04 is certified by the National Marine Electronics Association.*

## Appendix D. Example of a Configuration File YDEG.TXT

Contents listed below of the file correspond to the factory settings.

```
# Current configuration of Yacht Devices Engine Gateway
# Firmware: 1.31 19/05/2019 BETA 4

ENGINE_CAN_SPEED=250

ENGINE_0=0
ENGINE_1=1
ENGINE_2=OFF
ENGINE_3=OFF
ENGINE_4=OFF
ENGINE_5=OFF
ENGINE_6=OFF
ENGINE_7=OFF
HOURS_OFFSET=0

BRP_ROTAX=OFF
SMARTCRAFT=OFF
VOLCANO=OFF
EDC2=OFF
MEFI4B=OFF

# Reset when switching SMARTCRAFT or MEFI4B settings, use CALIBRATE_TRIM
TRIM_ZERO=28708
TRIM_STEP=128

EXHAUST_TEMP=ON
INTAKE_MANIFOLD_TEMP=OFF

NMEA_BATTERY=KEYSWITCH

BATTERY_0=0
BATTERY_1=1
BATTERY_2=OFF
BATTERY_3=OFF
```

BATTERY\_4=OFF  
BATTERY\_5=OFF  
BATTERY\_6=OFF  
BATTERY\_7=OFF

NMEA\_ALTERNATOR=KEYSWITCH

FUEL=DIESEL

FUEL\_0=0, PORT  
FUEL\_1=0, STARBOARD  
FUEL\_2=OFF  
FUEL\_3=OFF  
FUEL\_4=OFF  
FUEL\_5=OFF  
FUEL\_6=OFF  
FUEL\_7=OFF  
FUEL\_8=OFF  
FUEL\_9=OFF

TANK\_CAPACITY\_0=DEFAULT  
TANK\_CAPACITY\_1=DEFAULT  
TANK\_CAPACITY\_2=DEFAULT  
TANK\_CAPACITY\_3=DEFAULT  
TANK\_CAPACITY\_4=DEFAULT  
TANK\_CAPACITY\_5=DEFAULT  
TANK\_CAPACITY\_6=DEFAULT  
TANK\_CAPACITY\_7=DEFAULT  
TANK\_CAPACITY\_8=DEFAULT  
TANK\_CAPACITY\_9=DEFAULT

TANK\_CALIBRATION\_0=OFF  
TANK\_CALIBRATION\_1=OFF  
TANK\_CALIBRATION\_2=OFF  
TANK\_CALIBRATION\_3=OFF  
TANK\_CALIBRATION\_4=OFF  
TANK\_CALIBRATION\_5=OFF  
TANK\_CALIBRATION\_6=OFF  
TANK\_CALIBRATION\_7=OFF

TANK\_CALIBRATION\_8=OFF  
TANK\_CALIBRATION\_9=OFF

MDI\_PROP\_MESSAGE=ON  
MDI\_AUX\_MASK=000000  
MDI\_SYS\_FAULT\_MASK=000000

ALERT\_0=OFF  
ALERT\_1=OFF  
ALERT\_2=OFF  
ALERT\_3=OFF  
ALERT\_4=OFF  
ALERT\_5=OFF  
ALERT\_6=OFF  
ALERT\_7=OFF  
ALERT\_8=OFF  
ALERT\_9=OFF

ALERT\_WARN1\_MASK=000000  
ALERT\_WARN2\_MASK=000000  
ALERT\_POWER\_REDUCTION\_MASK=000000

NMEA\_ALERT\_MASK=FFFFFF

TRANSMISSION\_0=3  
TRANSMISSION\_1=4  
TRANSMISSION\_2=OFF  
TRANSMISSION\_3=OFF  
TRANSMISSION\_4=OFF  
TRANSMISSION\_5=OFF  
TRANSMISSION\_6=OFF  
TRANSMISSION\_7=OFF

TRANS\_ALERT\_0=OFF  
TRANS\_ALERT\_1=OFF  
TRANS\_ALERT\_2=OFF  
TRANS\_ALERT\_3=OFF  
TRANS\_ALERT\_4=OFF  
TRANS\_ALERT\_5=OFF

TRANS\_ALERT\_6=OFF  
TRANS\_ALERT\_7=OFF  
TRANS\_ALERT\_8=OFF  
TRANS\_ALERT\_9=OFF

TRANMISSION\_ALERT\_MASK=1F

WATER\_DEPTH\_OFFSET=OFF  
WATER\_SPEED\_CORRECTION=OFF  
WATER\_TEMP\_OFFSET=OFF

PASS\_PGN=OFF  
PASS\_ADDR=AS\_IS

J\_PASS\_PGN=OFF  
J\_PASS\_ADDR=210

# For ENGINE\_0 or TRANSMISSION\_0, data instance +1 will be used for ENGINE\_1, etc.

SUBSTITUTE\_BOOST=OFF  
SUBSTITUTE\_FUEL\_PRESSURE=OFF  
SUBSTITUTE\_OIL\_PRESSURE=OFF  
SUBSTITUTE\_OIL\_TEMP=OFF  
SUBSTITUTE\_CLNT\_PRESSURE=OFF  
SUBSTITUTE\_CLNT\_TEMP=OFF  
SUBSTITUTE\_TRANS\_PRESSURE=OFF  
SUBSTITUTE\_TRANS\_TEMP=OFF

# End of file

## Appendix E. Device Connectors

V+, V- - Battery 12V; CAN H, CAN L - NMEA 2000 data;  
SCREEN - Not connected in the Device.

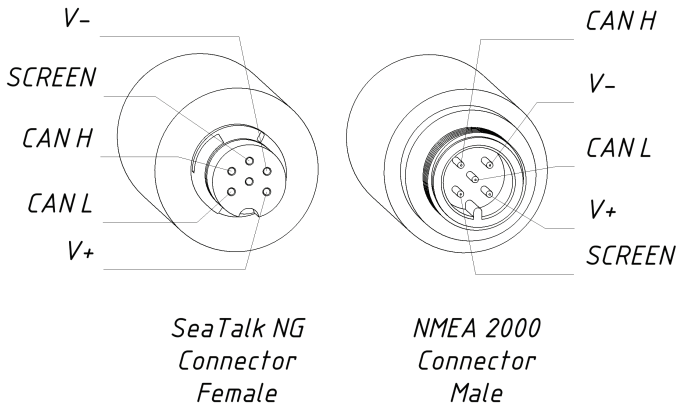
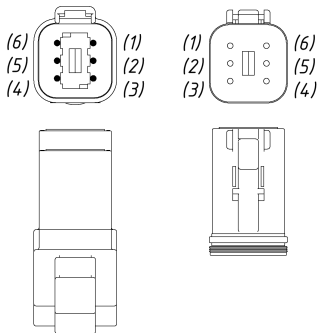

Figure 1. NMEA 2000 connectors of the YDEG-04R (left) and YDEG-04N (right) models



## *6-pin Deutsch connector*

- (1) - CAN1 LOW, Green or Blue*
- (2) - CAN2 LOW, Brown*
- (3) - CAN1 HIGH, Yellow*
- (4) - GND (negative supply, ground), Black*
- (5) - CAN2 HIGH, White*
- (6) - VCC (positive supply, 10..30V), Red*

*Pins (2) and (5) are not connected to the Device.*

*Figure 2. Engine connectors, DTo4-6P (male, left) and u DTo6-6S (female, right)*

In the additional connector's plug supplied with the Device, contacts (1) and (2) as well as contacts (3) and (5) are closed with each other. In this way, CAN1 and CAN2 are united into a single network. Contacts (2) CAN2 LOW and (5) CAN2 HIGH are not connected to the Device.



## Appendix F. Adaptor for 8-pin EVC/Vodia Connector

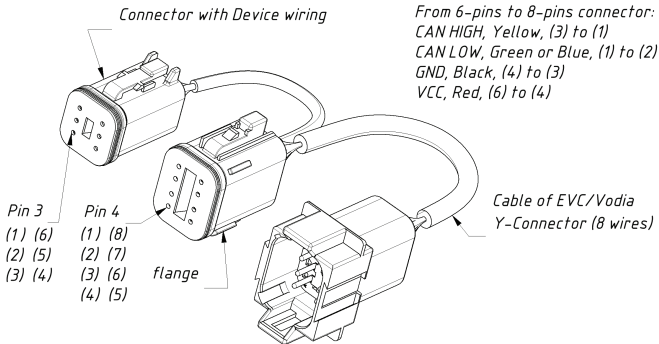

Figure 1. Adaptor for 8-pin EVC/Vodia connector

Colors of incoming wires of EVC/Vodia connector: (1) Blue/Pink [CAN HIGH], (2) Blue/White [CAN LOW], (3) Black [GND], (4) Red/Purple [VCC], (5) Purple [not connected in adaptor], (6) not connected, (7) Yellow/Red [not connected in adaptor], (8) not connected.

## Appendix G. Adaptor Cable for BRP Diagnostics Connector

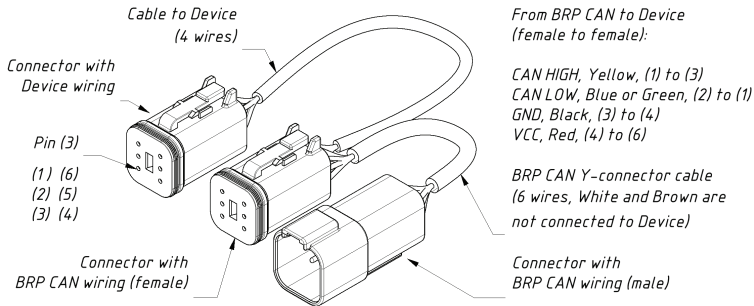

Figure 1. Adaptor Cable for BRP Diagnostics Connector

This cable contains built-in Y-connector. The Device can be connected in series with any of the existing equipment.

Colors of incoming wires of BRP diagnostics connector: (1) White/Red [CAN HIGH], (2) White/Black [CAN LOW], (3) Black [GND], (4) Purple or Yellow/Green or Grey/Red [not connected in adaptor], (5) Red/Purple or Purple [VCC], (6) not connected or Yellow/White.

## Appendix H. SmartCraft Data Supported by the Device

SmartCraft Data	NMEA 2000 PGN, Data Field [bit]
Engine Revolutions, RPM	127488, Engine Speed, RPM
Boost Pressure (Diesel)	127488, Engine Boost Pressure
Manifold Pressure (Gas)	127488, Engine Boost Pressure
Trim Position	127488, Engine Tilt/Trim
Oil Pressure	127489, Engine Oil Pressure
Oil Temperature	127489, Engine Oil Temperature
Coolant Temperature	127489, Engine Temperature
Battery Voltage	127489, Alternator Potential
Fuel Flow	127489, Fuel Rate
Engine Run Time	127489, Total Engine Hours
Block/Water Pressure	127489, Coolant Pressure
Fuel Pressure	127489, Fuel Pressure
Warn: Check Engine	127489, Engine Status [1]
Warn: Overheat	127489, Engine Status [2]
Warn: Low Oil Pressure	127489, Engine Status [3]
Warn: Low Oil Remote	127489, Engine Status [4]
Warn: Low Oil Reserve	127489, Engine Status [4]
Warn: Low Voltage	127489, Engine Status [6]
Warn: Low Block Pressure	127489, Engine Status [8]
Warn: Guardian Active	127489, Engine Status [19]
Warn: Water In Fuel	127489, Engine Status [9]
Warn: Overspeed	127489, Engine Status [13]
Fault: Check Engine/Guardian	127489, Engine Status [1]
Fault: CAN	127489, Engine Status [21]
Engine Load (Diesel)	127489, Percent Engine Load
Gear Pressure	127493, Transmission Oil Pressure
Gear Temperature	127493, Transmission Oil Temperature
Intake Mainfold Temperature	130316, Actual Temperature

<b>SmartCraft Data</b>	<b>NMEA 2000 PGN, Data Field [bit]</b>
Fuel Level 1	127505, Fluid Level
Fuel Level 2	127505, Fluid Level
Battery Voltage	127508, Battery Voltage