

# HX1 Horizontal Windlass

## Product manual - 65140050

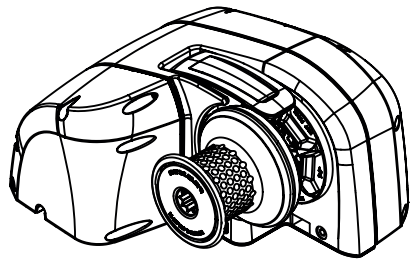
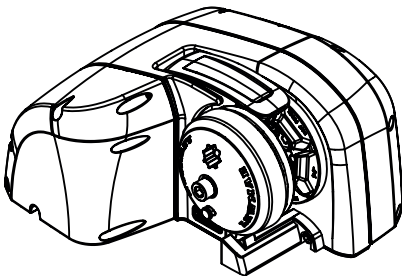
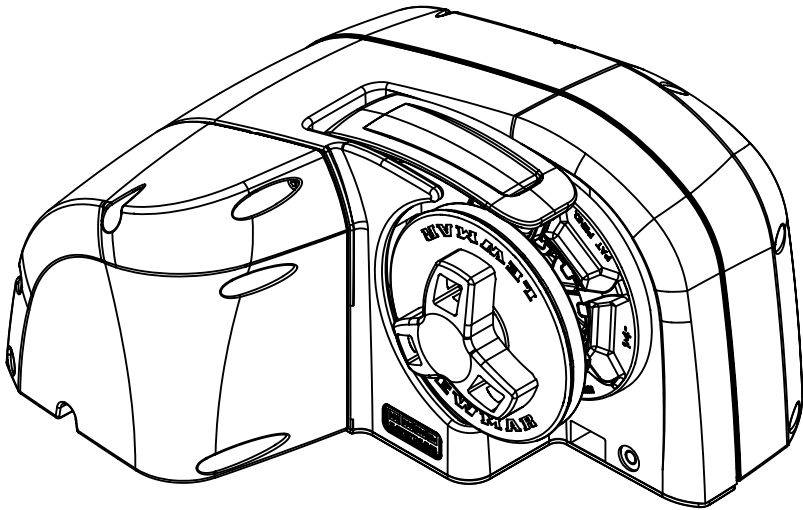

## 1. Introduction

Dear Customer,

Thank you for choosing Lewmar. Lewmar products are world renowned for their quality, technical innovation and proven performance. With a Lewmar product you will be provided with many years of outstanding service.

### Product support

Lewmar products are supported by a worldwide network of distributors and Authorised Service Representatives. If you encounter any difficulties with this product, please contact your national distributor, or your local Lewmar dealer. Details are available at: [www.lewmar.com](http://www.lewmar.com)

### CE Approvals

For CE approval certificates contact Lewmar.

### Important information about this manual

Throughout this manual, you will see safety and product damage warnings. You must follow these warnings carefully to avoid possible injury or damage.

The type of warnings, what they look like, and how they are used in this manual are explained as follows:

#### WARNING!

This is a warning against anything which may cause injury to people if the warning is ignored. You are informed about what you must or must not do in order to reduce the risk of injury to yourself and others.

#### SAFETY SYMBOL

When you see the safety symbol it means: "Do not..."; "Do not do this"; or "Do not let this happen".

---

## 2. Safety Notice

IMPORTANT: Read these notes before continuing.

 **WARNING!**

---

### 2.1 Windlass general

Classification Societies and Lewmar require that a vessel at anchor must have its chain/rode held by a chain stopper or equivalent strong point at all times

At all times it is the responsibility of the boat operator to ensure that the anchor and rode are properly stowed for the prevailing sea conditions. This is particularly important with high-speed powerboats, because an anchor accidentally deploying while under way can cause considerable damage. An anchor windlass is mounted in the most exposed position on a vessel and is thus subject to severe atmospheric attack resulting in a possibility of corrosion in excess of that experienced with most other items of deck equipment. As the windlass may only be used infrequently, the risk of corrosion is further increased. It is essential that the windlass is regularly examined, operated and given any necessary maintenance.

Please ensure that you thoroughly understand the operation and safety requirements of the windlass before commencing the installation. Only persons who are completely familiar with the controls and those who have been fully made aware of the correct use of the windlass should be allowed to use it. If there is any doubt of how to install or operate this unit please seek advice from a suitably qualified engineer.

- Windlasses used incorrectly could cause harm to equipment or crew.
- Windlasses should be used with care and treated with respect.
- Boating, like many other activities can be hazardous. Even the correct selection, maintenance and use of proper equipment cannot eliminate the potential for danger, serious injury or death.
- Lewmar windlasses are designed and supplied for anchor control in marine applications and are not to be used in conjunction with any other use.
- Keep limbs, fingers, clothing and hair clear of windlass, rode and anchor during operation. Severe bodily harm could result.
- Ensure there are no swimmers or divers nearby when dropping anchor.
- Windlasses must not be used as the sole means of securing the anchor to the bow fitting especially under storm conditions. Anchors should be independently secured to prevent accidental release.
- Classification Societies require that a vessel lying at anchor must have its anchor rope/chain secured to a chain stopper or other suitable independent strong point.
- A windlass should never be used as a mooring bollard, the anchor rode **MUST** be secured to a mooring cleat, chain stopper or other designated strong point. Using the windlass to secure the rode will damage the windlass.
- Do not use windlass for ANY purpose other than deployment and recovery of anchor.
- The circuit breaker in this product must never be deactivated or otherwise bypassed, it is intended to protect the motor and cables from overheating and damage.
- Always switch off this windlass at the circuit breaker/isolator when not in use.
- It is the unavoidable responsibility of the owner, master or other responsible party to assess the risk of any operation on the vessel.
- Windlass must not be operated whilst under the influence of alcohol or drugs.

---

### 2.2 Fitting

- This equipment must be installed and operated in accordance with the instructions contained in this manual. Failure to do so could result in poor product performance, personal injury and/or damage to your boat.
- Consult the boat manufacturer if you have any doubt about the strength or suitability of the mounting location.

---

### 2.3 Electrical

- Make sure that the boat's battery power supply has been switched off before starting the installation.
- This product requires installation by a suitably qualified electrical engineer.

## 3 - Installation

### 3.1 Basic requirements

Each installation requires the following tools:

#### WINDLASS INSTALLATION

- An appropriate marine sealant
- Electric drill and 10mm (3/8inch), 12mm (1/2inch) and 14mm (9/16inch) drill bits

- Jigg Saw

#### WIRING INSTALLATION

- Crimping Pliers / Wire Stripper
- Suitable electrical cable and crimp terminals

### 3.2 Accessories

Use only genuine Lewmar parts and accessories to ensure top performance and eliminate the risk of voiding your warranty. For replacement parts, please visit your dealer or [www.lewmar.com](http://www.lewmar.com)

### 3.3 Gypsy Suitability

Gypsies fitted to the HX1 windlasses are ideally suited to handling our factory made Rope/Chain combination rodes, which consist of rope spliced to a chain tail.

Ropes used must be windlass grade, medium lay nylon. Ropes from different manufacturers have wide variations in stretch and consistency in diameter. Therefore, rope and chain from other manufacturers may require some experimentation to determine the optimum size.

Should you have difficulty in matching a gypsy to your chain please consult your local agent or our international network of distributors.

### 3.4 Above deck preparation

IMPORTANT - Plan location carefully and allow for the following:

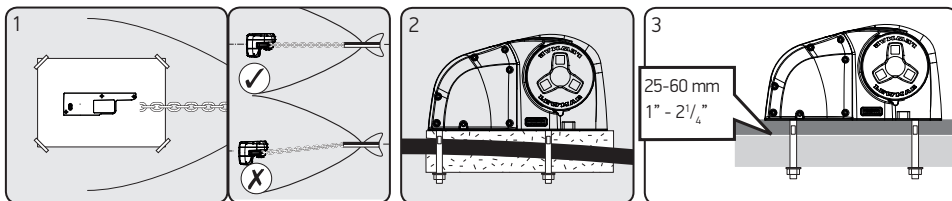

1. Use drilling template provided and choose an appropriate position with reference to the vessel's bow roller and the chain locker below. Allow for the rotation of the manual operating wrench handle
2. If the deck is not flat, a suitable mounting pad may be required to take up camber or sheer.  
NOTE: If in doubt about the suitable construction of the pad consult a qualified marine engineer.  
The deck is an integral component of the windlass it has to secure the windlass and be strong enough to cope with the high torque stresses involved in recovering the anchor. Decks that are thin, or of foam or balsa laminate construction, will require reinforcement in order to spread the loads that will be applied to the deck while the windlass is in use.
3. Lewmar recommends a minimum deck thickness of 25mm (1\"), M8 Studs suit deck and packing thickness of 25-60mm (1\" - 2 1/4\").

### 3.5 Below deck preparation

IMPORTANT: The positioning of the windlass must be checked prior to cutting for deck/hull and bulkhead clearance.

Lead from the roller should be fed horizontally back to the top of the gypsy and along its centre line within  $+6^\circ$ . There must be sufficient vertical fall (minimum of 300 mm / 12\" at all times) for the chain or rope when hauling in.

**⚠ WARNING! Failure to provide minimum vertical fall will cause jamming.**

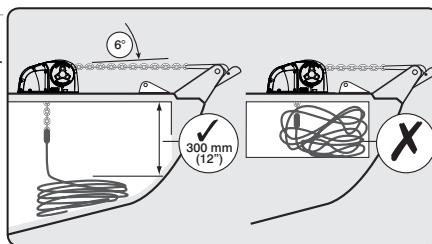

## 3.6 Above deck fitting

Using the template and after you have checked all the above and below deck requirements cut the following holes:

Using 10mm drill bit, make the three holes for the mounting studs and three for the chain hole. Use a 12mm drill bit make one hole for the chain hole, create the chain hole by cutting the between the four holes to create the chain hole. Using a 14mm drill bit make two holes to create the slot for the motor and chain sensor wires.

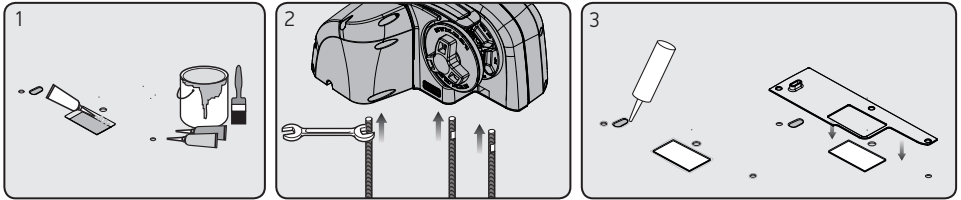

1. When all the holes have been made, remove the template. To help avoid water absorption by the deck, apply an appropriate marine sealant to the freshly cut hole edges.
2. Assemble and tighten studs into base until they bottom out in their holes. Studs have a flat for spanner location. Position the flats of the studs nearest the base of the windlass.
3. Place the windlass in position on the deck. Optionally, apply a suitable sealant to the base of the windlass, any mounting pad or around the studs.

## 3.7 Under deck fastening

1. Fit windlass to deck. Trim the studs back to 6mm ( $\frac{1}{4}$ " ) below the fully tightened nuts to prevent snagging anchor rope/chain if necessary.

NOTE: If using silicone or other rubbery type sealant, it is advisable to allow curing of the sealant before final tightening of the mounting nuts.

⊘ DO NOT use a permanent adhesive/sealant eg.5200

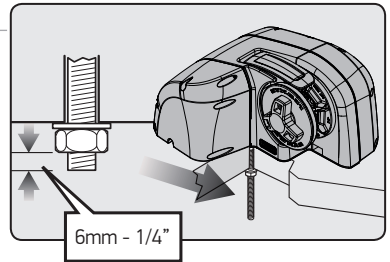

## 3.8 Loading rope/chain

For safety and performance Lewmar recommends the use of matched Lewmar anchor rods.

⚠ WARNING! Isolate (turn off) the windlass using circuit breaker / isolator.

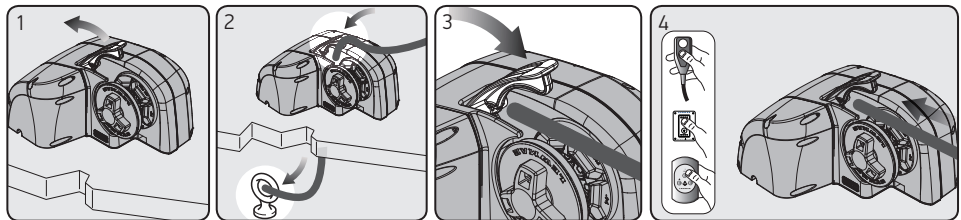

1. Pull out control arm. (Do not use excessive force)
2. Feed anchor rope/chain into entry hole. Tie off to suitable strong point in the anchor locker.
3. Align rope/chain in gypsy. Release control arm and wrap rope/chain around gypsy.
4. Turn on the breaker and power load rest of anchor rope/chain.

## 4- Electrical wiring

### 4.1 Electric cable selection

Lewmar recommends the installer source and install cable that meets the requirements of the standards and regulations relevant to the installation and codes of practice.

The cable table gives recommended cable sizes based on total length of cable required, from the battery, following the route of the cables.

⚠ DO NOT confuse cable length with the length of the vessel

MODEL	CABLE SIZING FOR LENGTH OF CABLE RUN					
	up to 7 m	up to 23 ft	7 - 15 m	23 - 50 ft	15 - 22 m	50 - 73 ft
HX1 500	6 mm <sup>2</sup>	10 AWG	10mm <sup>2</sup>	8 AWG	16 mm <sup>2</sup>	6 AWG
HX1 800	10 mm <sup>2</sup>	8 AWG	16 mm <sup>2</sup>	6 AWG	25 mm <sup>2</sup>	4 AWG

Windlass performance is directly related to cable size and length. Voltage drop over the complete wiring run must not exceed 10%.

### 4.2 Wiring

Plan the installation to suit the controls and give the operator a full view of the windlass. The wiring system should be of the fully insulated type, which avoids possible electrolytic corrosion problems. We recommend the use of type III stranded, tinned copper wire with copper crimp terminals. Most modern installations are negative return (negative ground) but polarity should be checked.

Overload protection, in the form of the circuit breaker provided must be built into the windlass wiring circuit.

- Circuit breaker supplied:  
HX1 500 - 50A (Part No 68000348)  
HX1 800 - 70A (Part No 68000240)
- The circuit breaker should be positioned close to the battery in a dry, readily accessible place.
- The breaker must be manually reset should an overload occur that causes it to trip to the off position.

⚠ WARNING!

- If you are not sure you understand these guidelines, seek professional help. Ensure that the installation complies with USCG, ABYC, NMMA or other local regulations.

### 4.3 Control switch installation

The unit is supplied with

- Guarded rocker switch (product ref 68000593)
- Contactor (product ref 68000939)

Follow the wiring diagram § 4.4

NOTE: Optional electric footswitches and remote handheld control available.

Visit [www.lewmar.com](http://www.lewmar.com) for more information

Contactor box and control box used in some installation refer to wiring diagram

Optional wireless remote also available

See table below for models and references

WIRELESS REMOTE (3 BUTTON WINDLASS ONLY)	WIRELESS REMOTE (5 BUTTON WINDLASS & THRUSTER)
68000967	68000968

NOTE: In a multi station installation all switches must be wired in a parallel circuit.

## 4.4 Wiring diagram using contactor provided (Part No 68000939)

Installation instructions are supplied separately with any accessories.

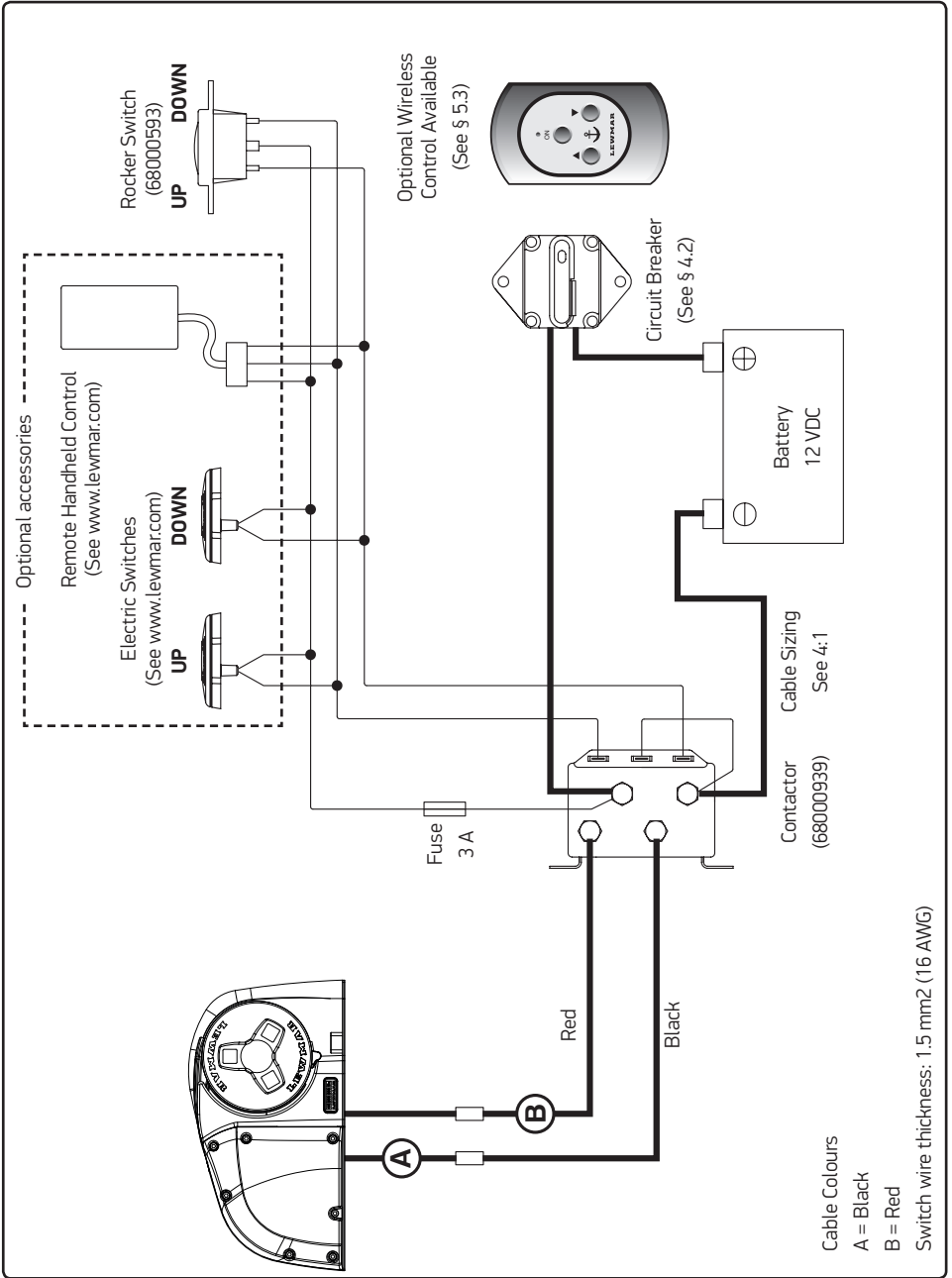

### 4.5 Wiring diagram if a contactor box (Part No 68000965) is used

Installation instructions are supplied separately with any accessories.

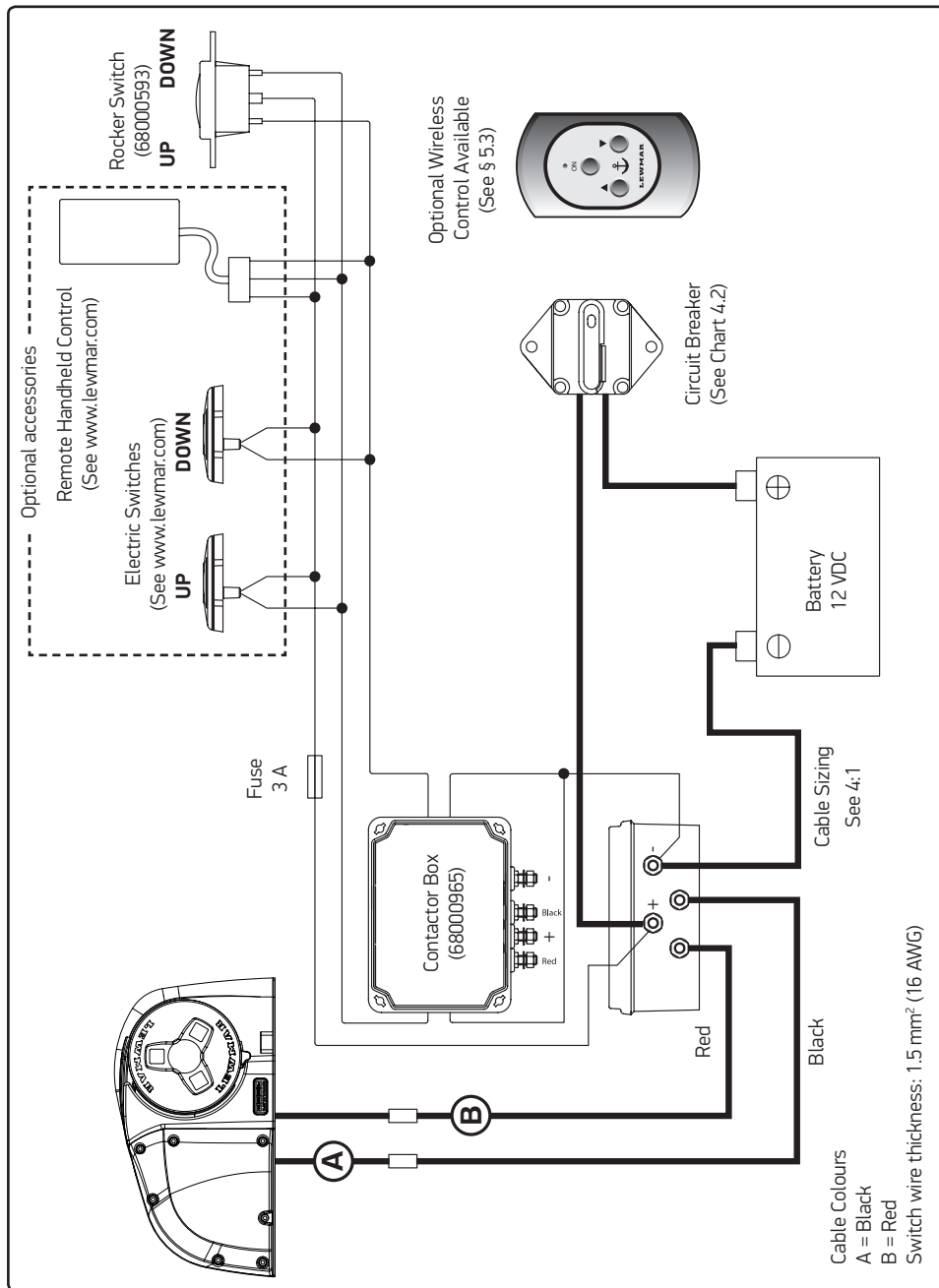



**4.6 Wiring diagram if a pre-wired control box (Part No 68000963) is used**

Installation instructions are supplied separately with any accessories.

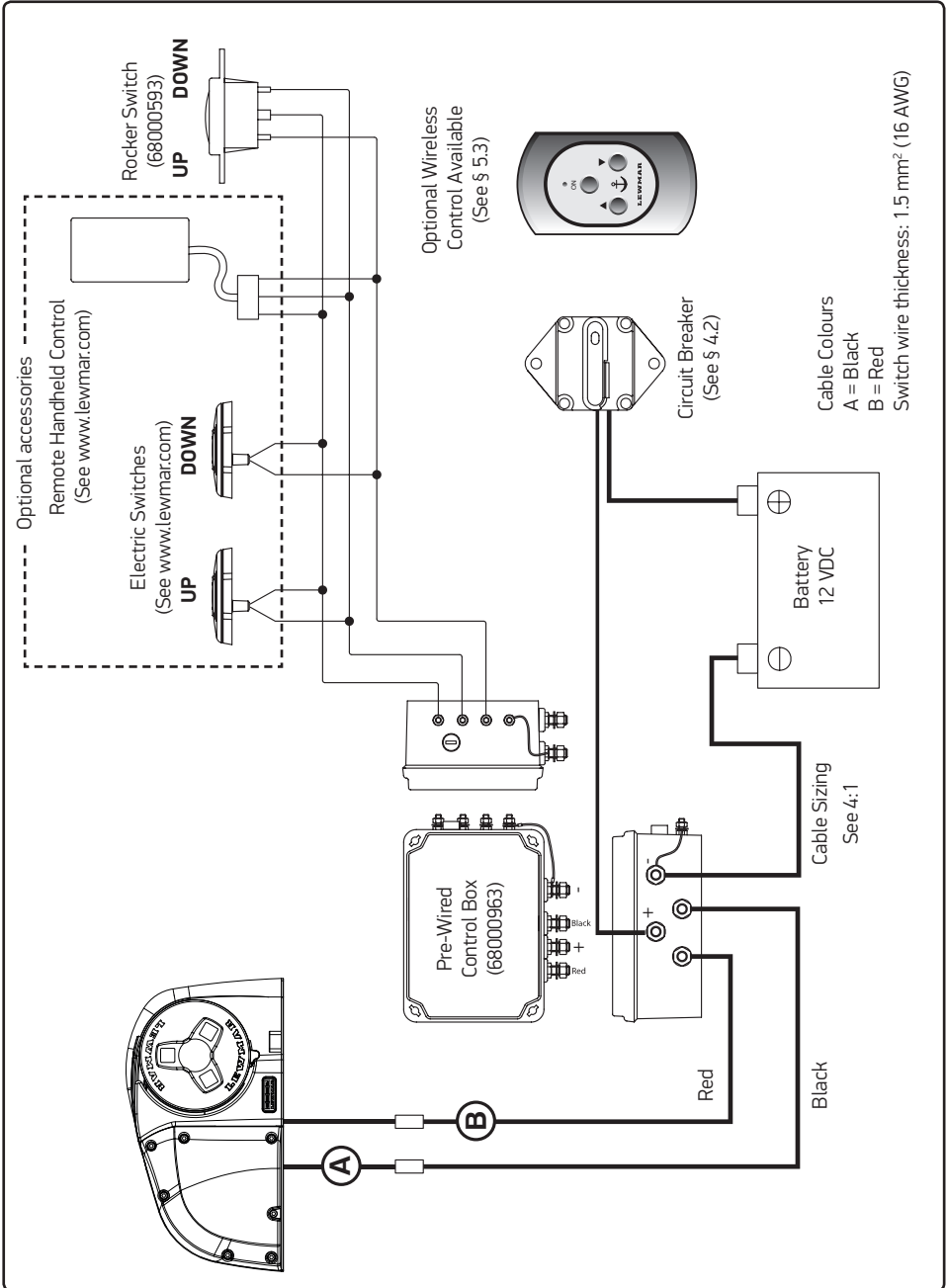

## 5- Operation

### 5.1 Manual controlled freefall Gypsy only

Use this method for quicker anchor deployment, in an emergency involving loss of power or to save battery power. Observe maritime anchor deployment safety rules.

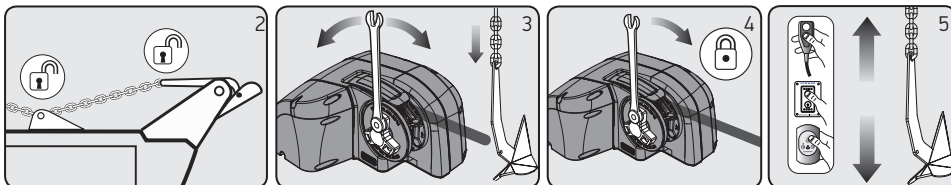

1. Engage the circuit breaker/isolator and press the up button.
2. Release any anchor locks
3. When safe, insert the Lewmar wrench in to the windlass drive cap. Rotate clockwise to grip the gypsy and anticlockwise to free the gypsy controlling the rate of descent of the anchor. Lock the clutch by turning the drive cap clockwise, Engage the anchor locks.
4. To return the windlass back to powered operation lock the clutch by rotating the windlass drive cap clockwise until tight and remove the wrench handle.
5. Engage the circuit breaker/isolator and press the up button.
6. NOTE: If the clutch nut is not tight the internal clutch mechanism will rotate freely and not engage the drive to the gypsy.

⚠ WARNING! Always remove wrench handle after use

### 5.2 Manual controlled freefall Gypsy Drum

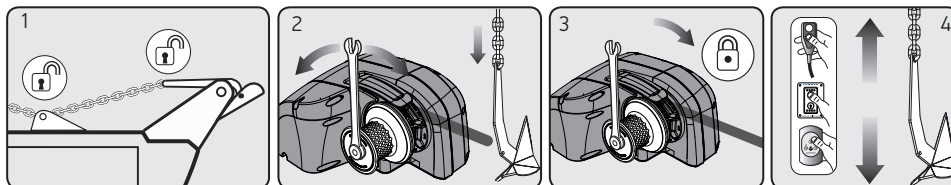

1. Engage the circuit breaker/isolator and press the up button.
2. Release any anchor locks
3. When safe, insert the Lewmar wrench in to the drum top cap. Rotate clockwise to grip the gypsy and anticlockwise to free the gypsy controlling the rate of descent of the anchor. Lock the clutch by turning the drum cap clockwise, Engage the anchor locks.
4. To return the windlass back to powered operation lock the clutch by rotating the Drum top cap clockwise until tight and remove the wrench handle.
5. Engage the circuit breaker/isolator and press the up button.
6. NOTE: If the Drum cap is not tight the internal clutch mechanism will rotate freely and not engage the drive to the gypsy.

⚠ WARNING! Always remove wrench handle after use

## 5.3 - HX1 Gypsy Only Operation

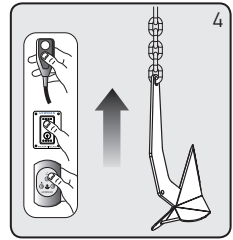
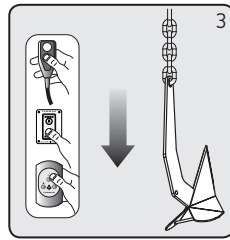
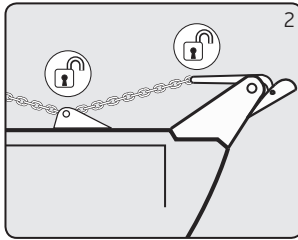
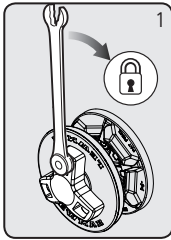

### To release anchor:

1. Check top cap is tight. If the clutch nut is not tight the internal clutch will rotate freely and not engage the drive.
2. Release any anchor locks.
3. Engage the circuit breaker/isolator. Press DOWN button.

### To retrieve anchor:

4. Press the UP button continuously to retrieve the anchor.

Note: If the clutch nut is not tight the internal clutch will rotate freely and not engage the drive.

## 5.4 - HX1 Gypsy Drum Operation

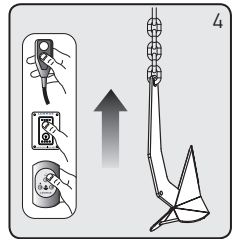
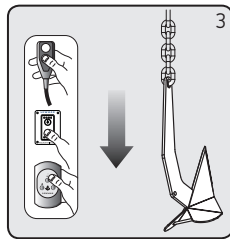
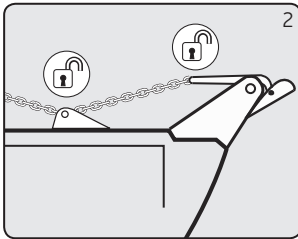
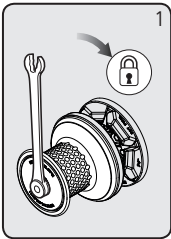

### To release anchor:

1. Check top cap is tight. If the clutch nut is not tight the internal clutch will rotate freely and not engage the drive to the capstan.
2. Release any anchor locks.
3. Engage the circuit breaker/isolator. Press DOWN button.

### To retrieve anchor:

4. Press the UP button continuously to retrieve the anchor.

Note: If the clutch nut is not tight the internal clutch will rotate freely and not engage the drive.

## 5.5 Windlass operating procedures

This is an anchor recovery device. DO NOT use the windlass to pull the boat to the anchor as it will damage the mechanism. Vessels at anchor will snub on the rode and this can cause slippage or apply excessive loads to the windlass. Best practice is to use a bollard or other strong point when at anchor and use the vessels engines to break the anchor free. Otherwise excessive load will cause the freefall function to seize and can cause damage to the gearbox.

⊘ When retrieving anchor do not overload or stall in windlass.

⊘ The rode should be secured directly to a bollard, sampson post or cleat and a chain secured by a chain stopper.

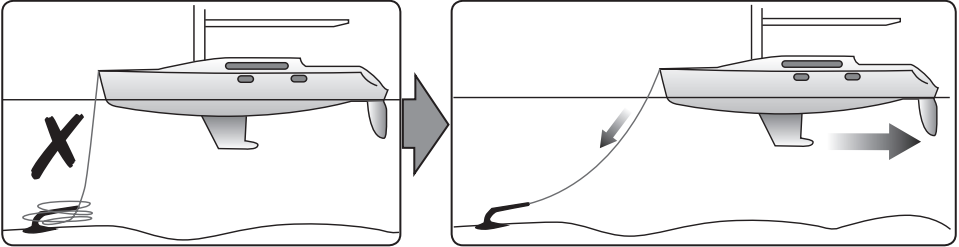

When anchoring, power rode out allowing the vessel to take up stern away preventing the rode tangling with anchor. Use this method for mooring stern first to a jetty.

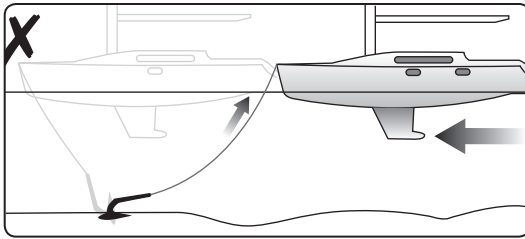

To aid recovery, under power, move vessel towards anchor but not over and beyond, as this can cause damage to topside.

As anchor approaches the vessel use careful adjustments of controls to avoid damaging vessel, start and stop the windlass to bring the anchor slowly into the bow roller.

Pulling the last bit of rode and anchor into the bow roller at full speed can damage the boat, bow roller and windlass.

When stowing it is important to make sure, particularly with rode lines that there is at least 300mm (12") of free space below the windlass (See §4.5). Stop and check during the stowing process to determine if there is sufficient space on you vessel. If the rode pile is too close to the underside of the windlass, re-distribute the rode away from directly below the windlass. If the rode gets too close to the underside of the windlass it will cause problems with good rode recovery and may cause damage to the line.

## 6- Servicing

⚠ WARNING! Isolate the windlass using circuit breaker/isolator

⚠ WARNING! Ensure rode is adequately secured to an independent strong point

### 6.1 Servicing schedule

The service period is determined by the frequency of use. Professional user will need to carry out these operations more often than the weekend user. Before commencing any work on this or any other electrical product, isolate from the power source.

Bedding in period:

When new there are some areas that will need frequent checking. If no movement is found they can be inspected less often.

- Examine all electrical connections, to make sure they are sound and corrosion hasn't set in. Tighten if necessary and protect if required.
- Check mounting studs are firmly clamped and tighten if required.

After use:

- Wash down the windlass using fresh water.
- Ensure rode is at least 12" (300mm) below the windlass
- Check anchor locker drain
- Check rode and splice for wear.

Annually or more often if frequent user:

- Examine all electrical connections, to make sure they are sound and corrosion hasn't set in. Tighten if necessary and protect if required.
- Check mounting studs are firmly clamped and tighten if required.
- Check rode and splice for wear.
- Check gypsy as it is a high wear item (For service and replacement see §8.2)
- Check main case for damage particularly around the seal and cover.

### 6.2 Gypsy Replace/Fitment on Gypsy Only version:

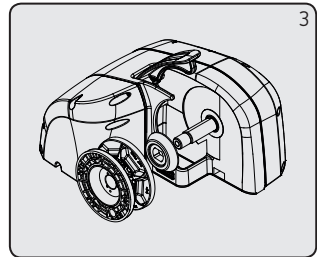
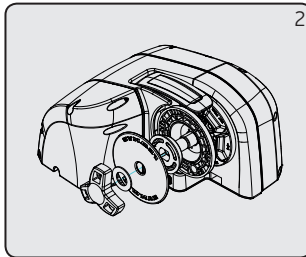
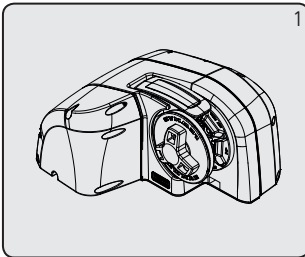

1. Release the clamp nut
2. Remove clamp nut, gypsy cap, upper cone washer and upper cone from the drive shaft
3. Pull control arm up out of the gypsy
4. Remove gypsy, and if required the lower cone from the drive shaft
5. Replace in reverse order, on re-assembly add a small smear of grease to the contact surfaces of the cones

### 6.3 Gypsy Replace/Fitment on Gypsy Drum version:

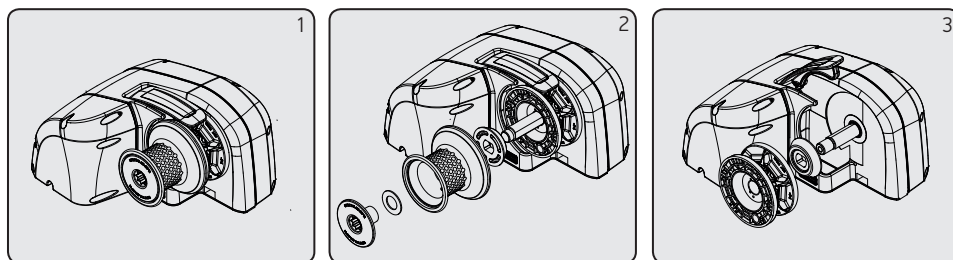

1. Remove the drum top cap
2. Remove drum top cap, Drum, upper cone washer and upper cone from the drive shaft
3. Pull control arm up out of the gypsy
4. Remove gypsy, and if required the lower cone from the drive shaft
5. Replace in reverse order, on re-assembly add a small smear of grease to the contact surfaces of the cones

### 6.4 Control Arm Replacement:

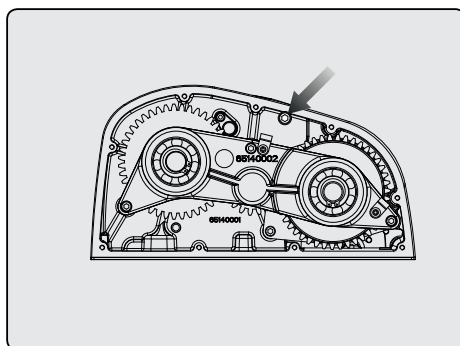
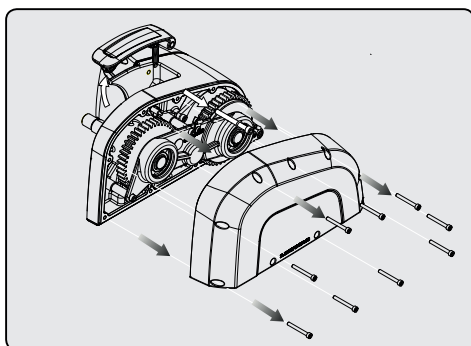

HX1 REAR COVER GASKET

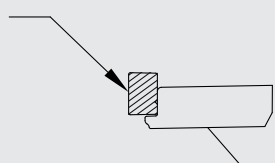

HX1 REAR COVER

1. Remove Gypsy, as above 6.3 & 6.4
2. Remove the rear casing by removing the nine holding screws, take gear of gasket
3. Unhook control arm spring from HX1 body
4. Remove control arm screw and O-ring
5. While the rear cover is off inspect the unit for wear on the gear train and bearings, re-grease where required
6. Replace in reverse order - Ensure that the rear Gasket cover is sitting correctly.

Note : Gasket is bonded to cover at point of manufacture.

## 7- Freefall Kit

### 7.1 Fitting

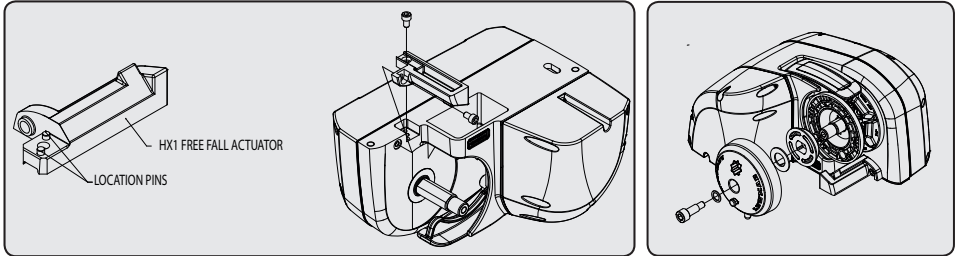

Fitting the Hx1 Freefall actuator

1. Remove Gypsy as per 6.4
2. Ensure that the location pins are securely fitted to the actuator
3. Push fit the actuator into the HX1 Body as shown
4. Secure actuator with screw supplied
5. Fit gypsy
6. Fit HX1 Free-fall cap by screwing onto shaft.
7. Smear a little threadlock to the fixing screw
8. Secure screw, trq 4Nm

### 7.2 Power up/down

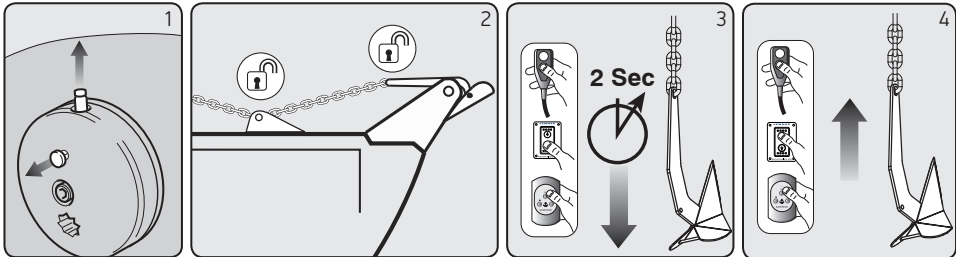

To release anchor:

1. Check unit is not in manual mode by ensuring button released plunger is extended.
2. Release any anchor locks.
3. Engage the circuit breaker/isolator.

When releasing the anchor, press DOWN button until the anchor is under freefall. If the clutch was left in a locked position the anchor will move almost immediately, if unlocked it could take several seconds to fully re-engage the internal clutch.

NOTE: Pressing the DOWN button for over 5 seconds will result in a longer clutch re-engagement time during the next UP command).

If using a rope/chain rode, motor astern to create the desired scope. Once scope has been created press the UP button continuously until freefall stops. It normally takes several seconds to fully re-engage the internal clutch mechanism, locking the windlass.

NOTE: Failure to lock the windlass clutch could result in rope/chain creeping out.

**To retrieve anchor:**

4. Press the UP button continuously to retrieve the anchor.

### 7.3 Manual controlled FreeFall

Use this method for quicker anchor deployment, in an emergency involving loss of power or to save battery power. Observe maritime anchor deployment safety rules.

⚠ WARNING! Isolate (Turn off) the windlass using circuit breaker / isolator.

⚠ WARNING! Trapping, crushing or entanglement danger whilst operating windlass manually or under power

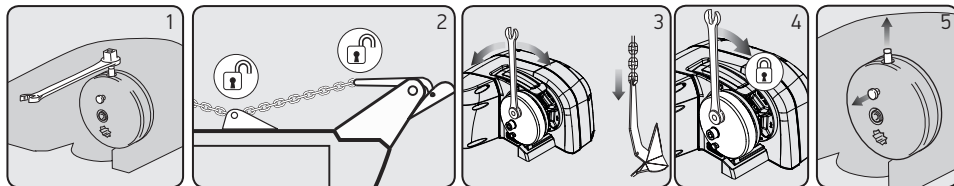

1. Disengage the drive by pressing the plunger button on the FreeFall drive cap and pressing the locking button until the plunger remains in the down position.

2. Release any anchor locks

3. When safe insert the Lewmar wrench in to the capstan drive cap. Rotate clockwise to grip the gypsy and anticlockwise to free the gypsy controlling the rate of descent of the anchor. Once deployed adjust desired scope if using a rope/chain, lock the clutch by turning the drive cap clockwise and engage the anchor locks. Remove the wrench handle.

⚠ WARNING! Always remove wrench handle after use

4. To return the windlass back to powered operation pull the locking button out disengaging the plunger. Engage the circuit breaker/isolator and press the UP/DOWN button.

### 7.4 Gypsy Replace/Fitment on Gypsy-FreeFall version:

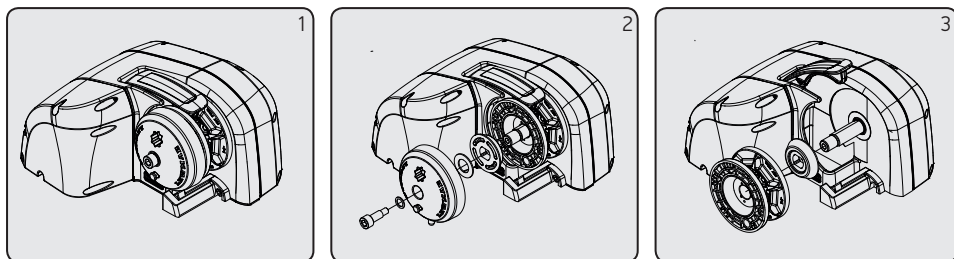

1. Undo the locking screw (This may require gentle heat to release threadlock)

2. Remove locking screw, washer, fish cap, upper cone washer and upper cone from the drive shaft

3. Pull control arm up out of the gypsy

4. Remove gypsy, and if required the lower cone from the drive shaft

5. Replace in reverse order, on re-assembly add a small smear of grease to the contact surfaces of the cones.

6. Add a small amount of thread lock to the locking screw before re-inserting



## 7.5 Auto Anchor Fitting

1. Remove the rear casing by removing the nine holding screws, take gear of gasket
2. Remove existing sensor
3. Fit existing sensor into Auto Anchor bracket
4. Fitting Auto Anchor sensor into fitting mount. See 7.5.5
5. While the rear cover is off inspect the unit for wear on the gear train and bearings, re-grease where required
6. Replace in reverse order - Ensure that the rear Gasket cover is sitting correctly

Note : Gasket is bonded to cover at point of manufacture.

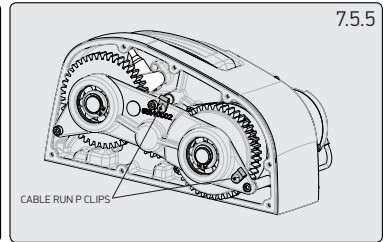
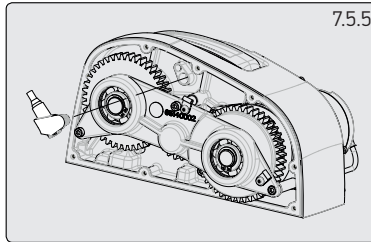
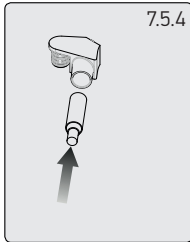
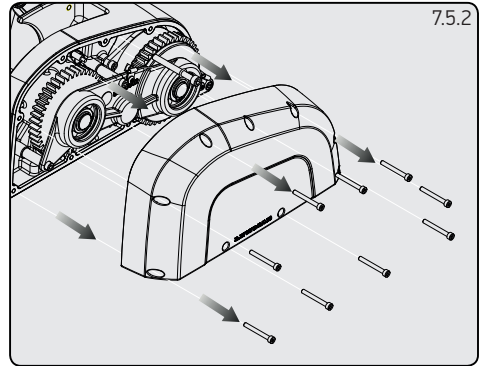



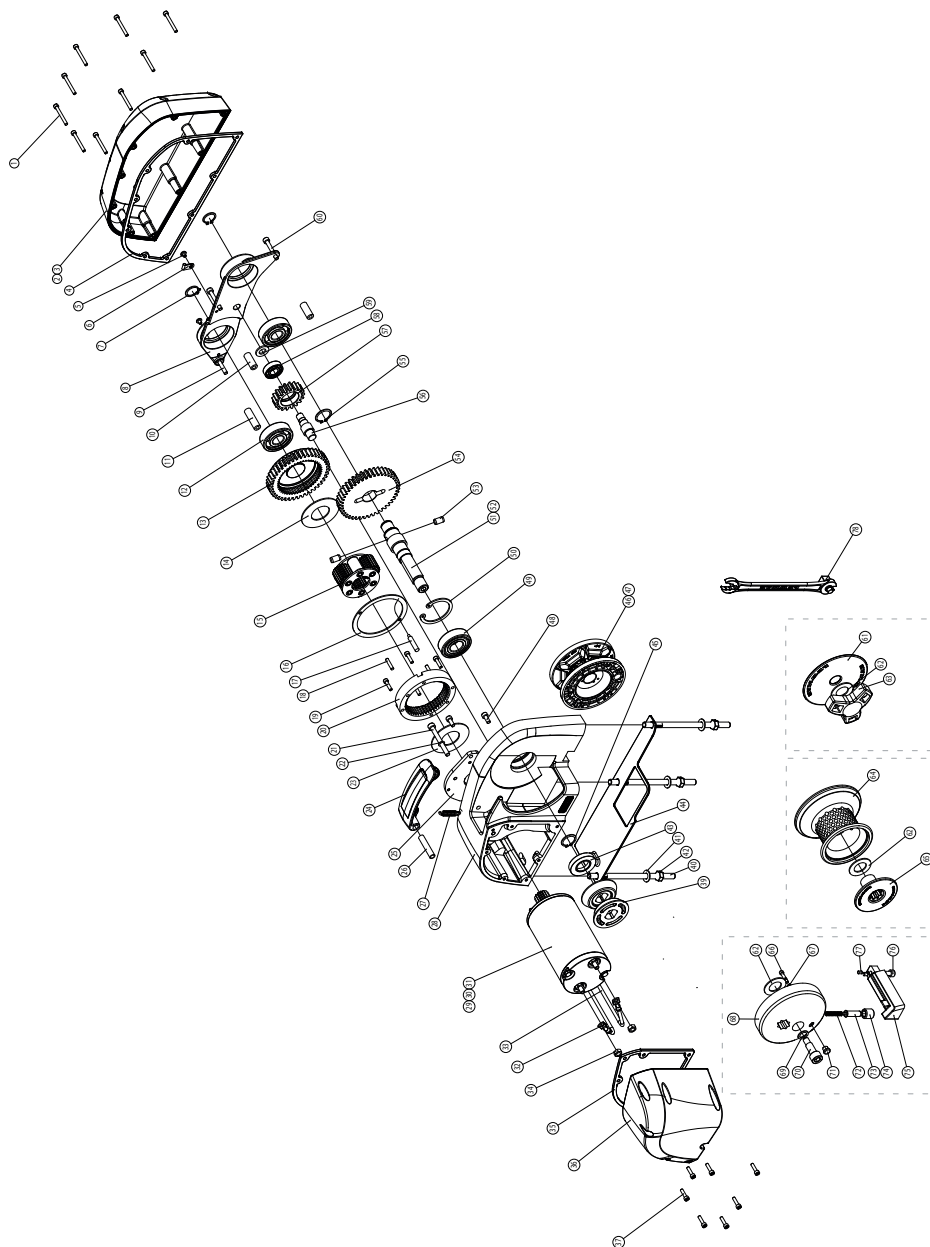

## 8. Specifications

### 8.1 Parts list



KIT NO	DESCRIPTION	ITEMS INCLUDED (QTY)
66100124	VX1 DRUM KIT	62(1), 63(1), 64(1),
66100139	VX1L/HX1 12v 500 MOTOR ASSY	29(1)
66100141	VX1L/HX1 12v 800 MOTOR ASSY	30(1)
66100142	VX1L/HX1 24v 800 MOTOR ASSY	31(1)
66140001	HX1 GASKET KIT	4(1), 35(1), 43(1)
66140002	HX1 DRIVE GO/GF KIT	12(1), 45(1), 49(1), 50(1), 51(1), 53(2), 54(1), 55(1),
66140003	HX1 DRIVE GD KIT	12(1), 45(1), 49(1), 50(1), 52(1), 53(2), 54(1), 55(1),
66140004	HX1 GEAR TRAIN ASSY 500w 12v	7(2), 8(1), 9(1), 10(2), 11(1), 12(1), 13(1), 14(1), 15(1), 16(1), 18(2), 19(4), 20(1), 23(1), 25(1), 29(1), 32(1), 33(1), 34(2), 56(1), 57(1), 58(1), 59(1), 60(2)
66140005	HX1 GEAR TRAIN ASSY 800w 12v	7(2), 8(1), 9(1), 10(2), 11(1), 12(1), 13(1), 14(1), 15(1), 16(1), 18(2), 19(4), 20(1), 23(1), 25(1), 30(1), 32(1), 33(1), 34(2), 56(1), 57(1), 58(1), 59(1), 60(2)
66140006	HX1 GEAR TRAIN ASSY 800w 24v	7(2), 8(1), 9(1), 10(2), 11(1), 12(1), 13(1), 14(1), 15(1), 16(1), 18(2), 19(4), 20(1), 23(1), 25(1), 31(1), 32(1), 33(1), 34(2), 56(1), 57(1), 58(1), 59(1), 60(2)
66140007	HX1 GYPSY CAP KIT	61(1), 62(1), 63(1)
66140008	HX1 FISH KIT	62(1), 66(1), 67(1), 68(1), 69(1), 70(1), 71(1), 72(1), 73(1), 74(1), 75(1), 76(1), 77(2)
66140009	HX1 CONTROL ARM KIT	21(1), 22(1), 24(1), 26(1)
66140010	HX1 POLYMER COVER KIT	2(1), 4(1), 35(1), 36(1)
66140011	HX1 ALLOY COVER KIT	3(1), 4(1), 35(1), 37(1)
66140012	HX1 BASE MATT ☉ KIT	40(3), 41(3), 42(3), 44(1), 78(1),
68140009	HX1 6/7mm 1/4" GYPSY ASSY	39(2), 46(1)
68140010	HX1 8mm GYPSY ASSY	39(2), 47(1)

## 8.2 HX1 Dimensions

		D		P		W	
		(mm)	(inch)	(mm)	(inch)	(mm)	(inch)
		6 mm ISO 4565	0.236	18	0.709	21.6	0.85
		6mm Dln766	0.236	18.5	0.728	20.4	0.803
		7mm ISO 4565	0.276	21	0.826	23	0.905
		7mm Dln766	0.276	22	0.866	23.8	0.937
		1/4" G40	0.276	21.3	0.840	24.4	0.962
68140010		1/4" BBB	0.281	22.1	0.870	25.2	0.992
		8mm ISO 4565	0.315	24	0.945	28.8	1.134
		8mm Dln766	0.315	24	0.945	27.2	1.07
		8.4	0.329	26.2	1.030	29.7	1.168

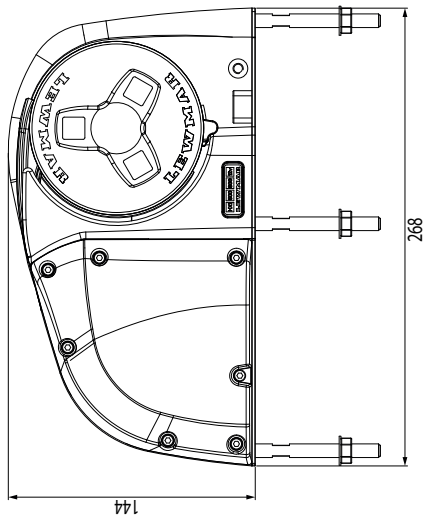

**8.3 HX1 Deck Mounting Detail**

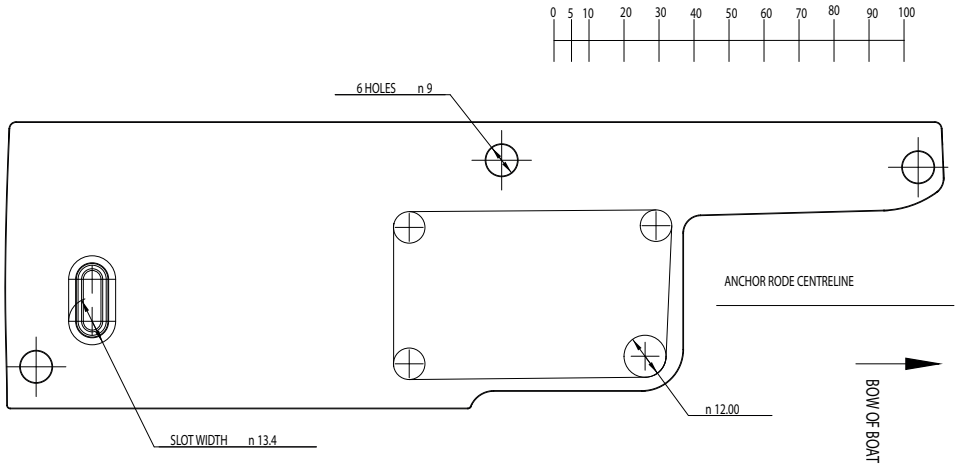

**8.4 Electric specifications**

MODEL	POWER OPTION	MOTOR	TYPICAL MAX. PULL		MAXIMUM LINE SPEED		TYPICAL WORKING LOAD	
	V	W	KG	LB	M/MIN	FT/MIN	KG	LB
<b>HX1 500</b>	12	500	700	1543	20	60	175	383
<b>HX1 800</b>	12	800	1065	2348	21	63	266	586

\*Values tested at +/- 10% on 12/24V system typical of electric systems installed on boats

MODEL	CURRENT DRAW AT WORK LOAD	TOTAL WEIGHT GYPSY ONLY		TOTAL WEIGHT GYPSY/DRUM		CIRCUIT BREAKER
	A	KG	LB	KG	LB	A
<b>HX1 500</b>	42	9	20	9.5	21	70
<b>HX1 800</b>	60	9	20	9.5	21	90

\* +1kg for Aluminium HX1 units.

---

## 9- Troubleshooting

1. Anchor rode pays out independently while windlass is not in use.
  - This problem is a result of not securing the anchor rode combined with the gypsy drive cap being slack. Tighten the gypsy drive cap using the winch handle and always secure the anchor rode independently of the windlass when not in use.
2. Failure to operate or sluggish operation.
  - The majority of these problems are electrical in nature. It is essential that the proper voltage be maintained. The proper voltage on a 12 Volt system is 13.5 Volts, constant low voltage will damage the motor.
  - Ensure electrical cable size is large enough to handle the current draw and keep voltage drop within acceptable limits.
  - Check control switches, connections, battery condition, isolator switch, fuse and motor for operation failure.
3. Failure to operate.
  - Is there a voltage at the input terminals to the contactor and switches. Check the circuit breaker/isolator switch and any fuses.
  - Operate the switch. Is there voltage at the positive switch terminal on the solenoid. If not, the switch (or its wiring), is defective.
  - Keep the switch activated. Is there voltage at the main output terminal on the contactor. If not check the contactor coil ground circuit. If okay, replace the contactor.
  - Check the voltage at the motor. If voltage of at least 12.5 volts is present and the motor does not operate, the motor is defective.

## 10 - Warranty

### Limited Warranty and Key Terms of Supply by Lewmar

Lewmar warrants that in normal private pleasure boat usage and with proper maintenance its products will conform with their specification for a period of three years from the date of purchase by the end user, subject to the conditions, limitations and exceptions listed below. Any product, which proves to be defective in normal usage during that three-year period, will be repaired or, at Lewmar's option, replaced by Lewmar.

#### A CONDITIONS AND LIMITATIONS

- i Lewmar's liability shall be limited to the repair or replacement of any parts of the product which are defective in materials or workmanship.
- ii Responsibility for the selection of products appropriate for the use intended by the Buyer shall rest solely with the Buyer and Lewmar accepts no responsibility for any such selection.
- iii Lewmar shall not be liable in any way for Product failure, or any resulting loss or damage that arises from:
  - a. use of a product in an application for which it was not designed or intended;
  - b. corrosion, ultra violet degradation or wear and tear;
  - c. a failure to service or maintain the product in accordance with Lewmar's recommendations;
  - d. faulty or deficient installation of the product (unless conducted by Lewmar);
  - e. any modification or alteration of the product;
  - f. conditions that exceed the product's performance specifications or safe working loads.
- g. Abuse
- iv Product subject to a warranty claim must be returned to the Lewmar outlet that supplied the product for examination unless otherwise approved by Lewmar in writing.
- v This warranty does not cover any incidental costs incurred for the investigation, removal, carriage, transport or installation of product.
- vi Service by anyone other than authorized Lewmar representatives shall void this warranty unless it accords with Lewmar guidelines and standards of workmanship.
- vii Lewmar's products are intended for use only in the marine environment. Buyers intending to use them for any other purpose should seek independent professional advice as to their suitability. Lewmar accepts no liability arising from such other use.

#### B EXCEPTIONS

Cover under this Warranty is limited to a period of one year from the date of purchase by the end user in the case of any of the following products or parts of products:

- Electric motors and associated electrical equipment
- Electronic controls
- Hydraulic pumps, valves and actuators
- Hatch & Portlight weather seals
- Products used in "Grand Prix" racing applications
- Products used in commercial or charter applications
- Anchor rodes

#### C LIABILITY

- i Lewmar's liability under this warranty shall be to the exclusion of all other warranties or liabilities (to the

extent permitted by law). In particular (but without limitation):

- a. Lewmar shall not be liable for:
  - Any loss of anticipated turnover or profit or indirect, consequential or economic loss;
  - Damages, costs or expenses payable to any third party;
  - Any damage to yachts or equipment;
  - Death or personal injury (unless caused by Lewmar's negligence).
- Some states and countries do not allow the exclusion or limitation of incidental or consequential damages, so the above limitation or exclusion may not apply to you
- b. Lewmar grants no other warranties regarding the fitness for purpose, use, nature or satisfactory quality of the products.
- ii Where applicable law does not permit a statutory or implied warranty to be excluded, then such warranty, if permitted by that state or country's law, shall be limited to a period of one year from the date of purchase by the end user. Some states and countries do not allow limitations on how long an implied warranty lasts, so this limitation may not apply to you.

#### D PROCEDURE

Notice of a claim for service under this warranty shall be made promptly and in writing by the end user to the Lewmar outlet that supplied the product or to Lewmar Limited at Southmoor Lane, Havant, Hampshire PO9 1JJ, England.

#### E SEVERANCE CLAUSE

If any clause of this warranty is held by any court or other competent authority to be invalid or unenforceable in whole or in part, the validity of the remaining clauses of this warranty and the remainder of the clause in question shall not be affected.

#### F OTHER RIGHTS

This warranty gives you specific legal rights, and you may also have other legal rights, which vary from state to state and country to country. In the case of European States a Consumer customer (as defined nationally) has legal rights under the applicable national law governing the sale of Consumer Goods; this Warranty does not affect those rights.

#### G LAW

This warranty shall be governed by and read in accordance with the laws of England or the state or country in which the first end user is domiciled at the time of purchase of the product.

#### H DISPUTES

Any dispute arising under this warranty may, at the option of the end-user, be referred to alternative dispute resolution under the rules of the British Marine Federation or to the Courts of the State whose law shall govern the warranty or to the Courts of England and Wales.

The British Marine Federation may be contacted at Marine House, Thorpe Lea Road, Egham, England, TW20 8BF

## **UK & International Distribution**

Lewmar  
Southmoor Lane  
Havant  
Hampshire  
PO9 1JJ  
England

**Tel:** +44 (0)23 9247 1841

**Fax:** +44 (0)23 9248 5720

**Email:** [info@lewmar.com](mailto:info@lewmar.com)

## **USA**

Lewmar  
351 New Whitfield Street  
Guilford, CT  
06437  
USA

**Tel:** +1 203 458 6200

**Fax:** +1 203 453 5669

**Email:** [info@lewmarusa.com](mailto:info@lewmarusa.com)

# **LEWMAR®**

**[www.lewmar.com](http://www.lewmar.com)**

Part No 65140050 iss.1