

Installation & Owner Manual

(For All Models ST780, ST980, ST1290, ST1610, MT1080, MT1175)

Designed for boats 10' - 28' in length with 8 to 300 hp engines.

The first and most effective automatic trim tab system provides better all around performance to even smaller boats with low hp engines.

Even if your boat runs "okay", **SMART TABS** will improve the performance of your boat more than you ever thought possible. All you do is drive, **SMART TABS** do the rest!

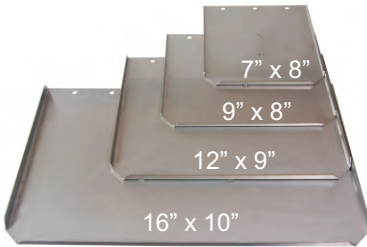

Patent # 6,095,077



Check Your model Here:

- | | | | |
|------------------------------------|------------------------------------|------------------------------------|-------------------------------------|
| <input type="checkbox"/> ST780-20 | <input type="checkbox"/> ST980-30 | <input type="checkbox"/> ST1290-60 | <input type="checkbox"/> ST1610-120 |
| <input type="checkbox"/> ST780-30 | <input type="checkbox"/> ST980-40 | <input type="checkbox"/> ST1290-80 | <input type="checkbox"/> ST1610-160 |
| <input type="checkbox"/> MT1175-60 | <input type="checkbox"/> MT1175-80 | <input type="checkbox"/> MT1080-60 | <input type="checkbox"/> MT1080-80 |

Notice: Use in SALT WATER requires zinc anodes.



Dear Customer;

Someone once said to me that the best designed product was not necessarily the most sophisticated, but the one that was simple yet served the customer effectively and reliably. A legitimate value!

We believe Smart Tabs fall into this category. The trim tab concept has been proven, the installation is simple, and the cost is reasonable.

Are Smart Tabs really that effective? You be the judge and let us know one way or another, because your satisfaction is our only goal when it comes to the development of products.

Thanks for purchasing Smart Tabs, and have many fun filled days with your boat.

*John E. DeAgro
President*



8080 Snowville Rd. - Brecksville - Ohio - 44141
Tel: 440-746-1290 . Toll Free: 800-233-0194 . Fax: 440-746-1291

INTRODUCTION

Thank you for choosing Nauticus Smart Tabs! We sincerely believe they will live up to all of the performance standards that we have set, for years to come. It is our goal to insure your satisfaction, and we ask that you participate in this partnership.

Please read this Manual so that you understand all of the benefits you can expect in performance from the simple installation procedure.

Principle of Operation:

Smart Tabs utilize a Nitrogen Gas filled Actuator to hold the trim plates down during low speed operation, and allow the water to “automatically” push the plates up (horizontal) at higher speeds. This provides additional “lift” to the stern at slow speeds creating a more level attitude.

ADVANTAGES

Reduced Bow Rise:

In addition to a more level ride at slower speeds, the minimum planing speed is significantly reduced. The result is that you will be able to run at the intermediate (comfortable) range which is not available without tabs. This may be especially important when in rough sea conditions.

Faster Hole Shot & Acceleration:

The additional “lift” not only reduces the “on plane” speed, but it allows the prop to efficiently attack the water, using all of the energy to propel the boat forward. Trimming the engine (which uses the prop energy to correct the boat attitude) can be minimized resulting in more forward thrust.

Improved Stability: (Especially at Top Speeds)

The additional surface/planing area on either side of the prop, with its continuous pressure, will improve high speed stability and minimize if not eliminate “chine walk” & porpoising.

Since the operation of each trim plate is independent, automatic, and speed sensitive the stability through turns will also improve. When turning the inside tab will take a shorter path than the outside tab, and tend to move down due to the lower water pressure. This also helps anchor the turn.

Improved Economy:

This advantage will come in two forms, reduced fuel consumption and reduced engine fatigue due to less resistance and stress.

Improved Safety:

Better visibility at slower speeds is an obvious advantage, but improved handling, reduced hull stress, and a smaller wake also add up to more safety.

Parts List

Note: Each Gas Actuator is coded with a colored cable clamp to denote the pressure as follows: all **Black** cable clamps = GA5000-80
 one **Blue** cable clamp = GA5000-60
 one **Red** cable clamp = GA5000-40
 one **Purple** cable clamp = GA5000-30
 one **Green** cable clamp = GA5000-20

ST 780's

Bag A- Hinge Kit = **1 ea**
 Bag B- Plate Bracket Kit = **1 ea**
 Bag C- Transom Bracket Kit = **1 ea**
 Bag D- Sealing Tape Kit = **1 ea**
 GA5000-20 or 30- 10" Gas Actuator w/boot = **2 ea**
 TP780- 7"x8" Stainless Steel Trim Tab = **2 ea**
 PH6150- 6" Stainless Steel Plate Hinge = **2 ea**

ST 980's

Bag A- Hinge Kit = **1 ea**
 Bag B- Plate Bracket Kit = **1 ea**
 Bag C- Transom Bracket Kit = **1 ea**
 Bag D- Sealing Tape Kit = **1 ea**
 GA5000-30 or 40- 10" Gas Actuator w/boot = **2 ea**
 TP980- 9"x8" Stainless Steel Trim Tab = **2 ea**
 PH8150- 8" Stainless Steel Plate Hinge = **2 ea**

ST 1290's

Bag A- Hinge Kit = **1 ea**
 Bag B- Plate Bracket Kit = **1 ea**
 Bag C- Transom Bracket Kit = **1 ea**
 Bag D- Sealing Tape Kit = **1 ea**
 GA5000-60 or 80- 10" Gas Actuator w/boot = **2 ea**
 TP1290- 12"x9" Stainless Steel Trim Tab = **2 ea**
 PH10155- 10" Stainless Steel Plate Hinge = **2 ea**

MT 1175 & MT1080

Bag A- Hinge Kit = **1 ea**
 Bag B- Plate Bracket Kit = **1 ea**
 Bag C- Transom Bracket Kit = **1 ea**
 Bag D- Sealing Tape Kit = **1 ea**
 GA5000-60 or 80- 10" Gas Actuator w/boot = **2 ea**
 TP1175 angled or MT1080- Stainless Steel Trim Tab = **2 ea**
 PH10155- 10" Stainless Steel Plate Hinge = **2 ea**

ST 1610's

Bag A- Hinge Kit = **1 ea**
 Bag B- Plate Bracket Kit = **2 ea**
 Bag C- Transom Bracket Kit = **2 ea**
 Bag D- Sealing Tape Kit = **1 ea**
 GA5000-30 or 40- 10" Gas Actuator w/boot = **4 ea**
 TP1610- 16"x10" Stainless Steel Trim Tab = **2 ea**
 PH14155- 14" Stainless Steel Plate Hinge = **2 ea**



Fig. #1

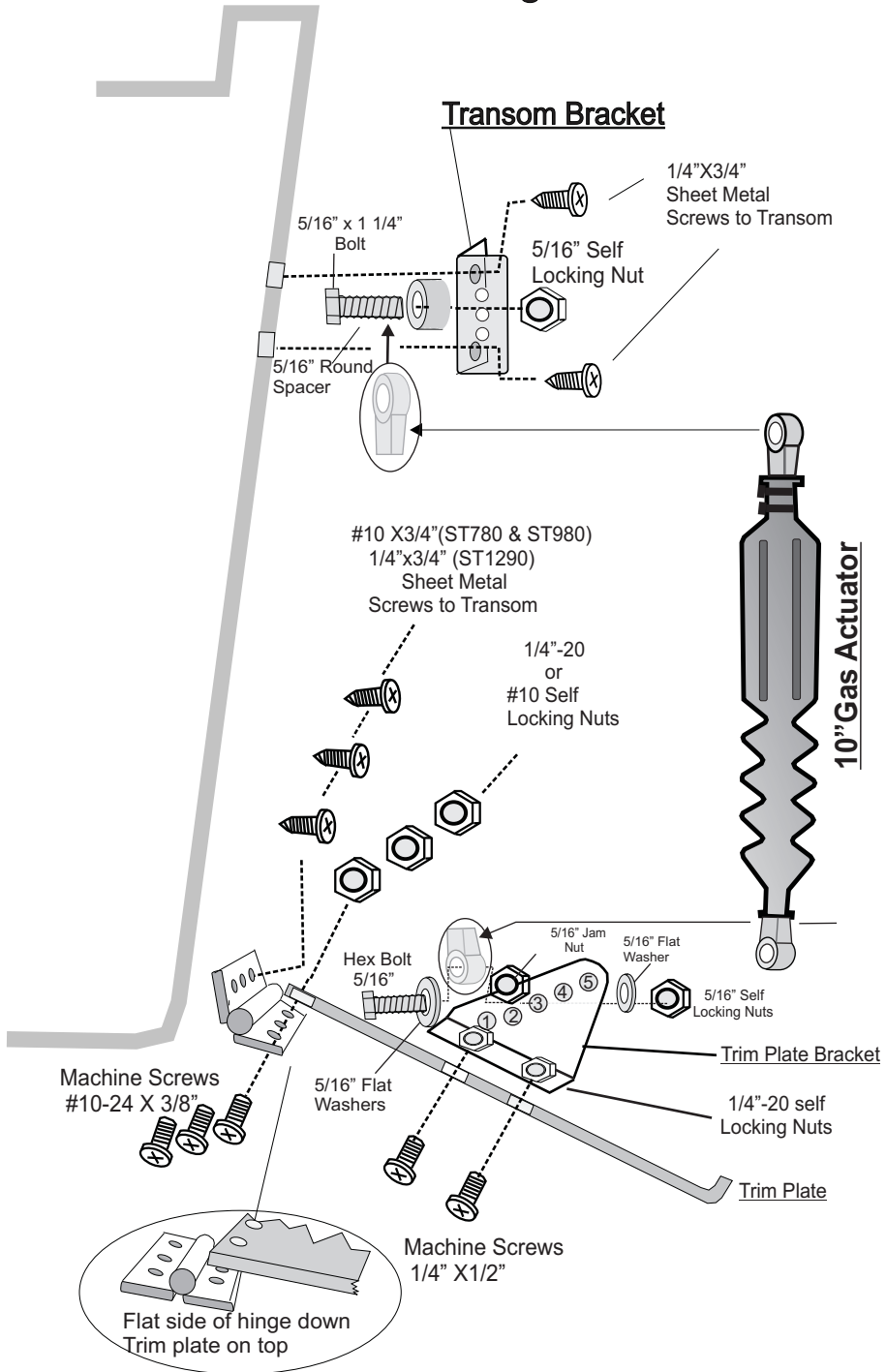

Assembly Instruction

1) Assemble all components before attempting installation on the boat: Refer to Fig #1 (page 3)

Bag "A"

- 1) Mount the hinges to the Trim Plates using the machine screws and self locking nuts. The self locking nuts should be on the top of the plate.

Bag "B"

- 1) Mount the Trim Plate Bracket to the Trim Plate using the 1/4" machine screws and 1/4" self locking nuts. Install the bracket in the 2 hole closest to the hinge. Use the extra hole to install a zinc if in salt water. If not then use the black push pins provided in the bag to fill in that extra hole. (**Note:** make sure that the angle of the Trim Plate Bracket is as shown in Fig. #1 and photos below.
 - 2) Attach the Actuator to the Trim Plate after the plate is mounted to the transom. The Actuator can be installed on either side of the bracket using the 5/16" hex head bolt, 5/16" washers, 5/15" jam nut, and 5/16" self locking nut. See pictures below.
- Note:** use the middle hole (#3) to start. Adjustments can be made after sea trial if required.



Insert the 5/16" bolt thru the end fitting, then the washer, then attach the hex jam nut HAND TIGHT but snug.



Use the self locking nut to attach the actuator **securely** to the plate bracket in hole #3. Use two 1/2" wrenches, one on the bolt and one on the self locking nut.

2) Mount the Trim Plate to the Transom Refer to Fig. #2

- A) Hold the Trim Plate (with hinge) against the bottom edge of the transom (1/2" up from the bottom) and mark the hole locations for the hinge, OR use the template from the center of this manual as directed on the template.
- B) Drill the holes in the transom (use 1/8" drill for Models ST780 & ST980, and 3/16" drill for aluminum and wood transoms or 7/32 on fiberglass transoms for ST1290 Models. Apply the Sealant Foam Tape over the hole on the transom.
- C) Mount both Trim Tab Plates securely using the sheet metal screws from Bag "A".



←
Tape the template from the center of the manual to the transom as indicated.

→
Use the self adhesive sealant foam tape to cover the holes.



←
Attach the trim plates to the transom, using the 1/4" x 3/4" sheet metal screws supplied.

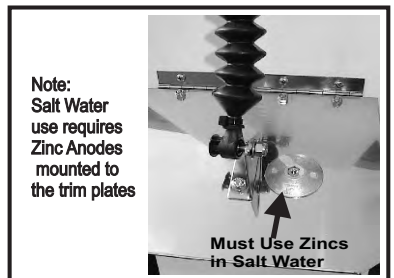

Note:
Salt Water use requires Zinc Anodes mounted to the trim plates

Must Use Zincs in Salt Water

Fig, #2A Standard RIB Design

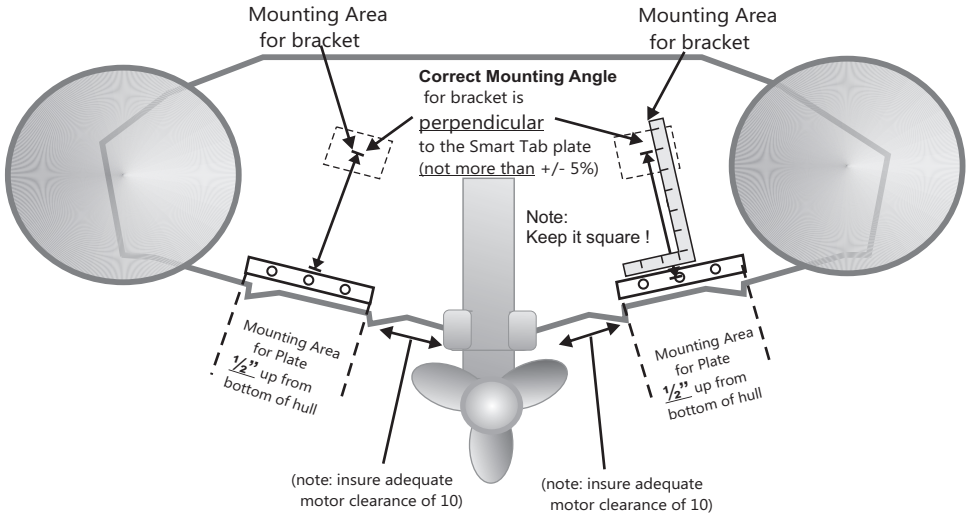

For the best lateral stability mount the plates just inside the chine, or as far outboard as possible depending on the hull configuration and other restrictions.

Fig, #2B Standard "V" Hull Designs

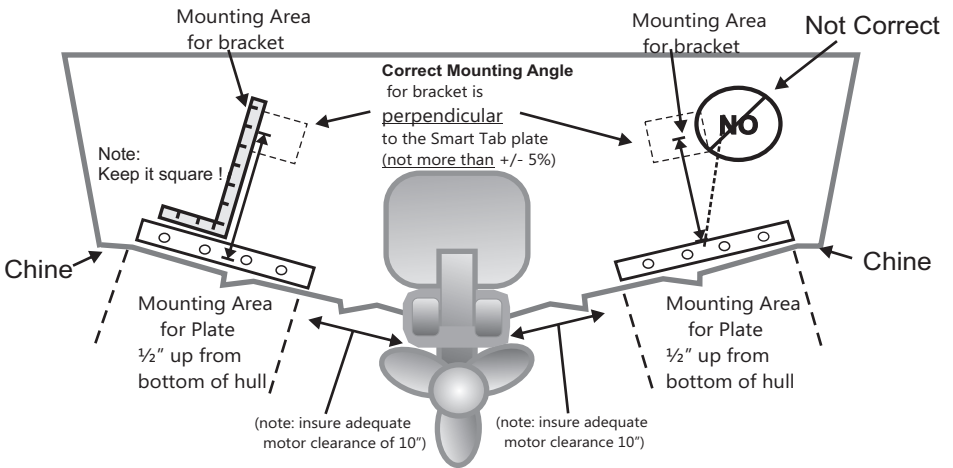

3) Mount the Gas Actuator and Transom Bracket:

Refer to Fig. 3A and Photo Below

- A) Cut the 25 degree templet from the Smart Tab box lid using the paper outline supplied.
- B) Attach the Smart Tab Gas Actuator onto both the Trim Plate Bracket and the Transom Bracket using the 5/16" hex bolt washers and self locking nuts.
- C) Hold the 25 degree templet against the bottom of the boat and allow the Trim Plate to rest on the templet (with the Gas Actuator attached).
- D) Place the Gas Actuator, with the transom Bracket attached, against the transom of the boat and mark the hole locations.

Refer to Figure. # 3B

Note: Make sure the Actuator is perpendicular to the hinge / plate.

- e) Drill the two holes in the transom using a 3/16" drill bit for wood or aluminum transom. Use a 7/32" drill bit for fiberglass transoms. Then cover both holes with the Marine Sealing Tape provided.
- F) Mount the Transom Bracket securely, using the sheet metal screws from Bag "C".



Fig. #3A

Transom Bracket Installation
25 degree angle

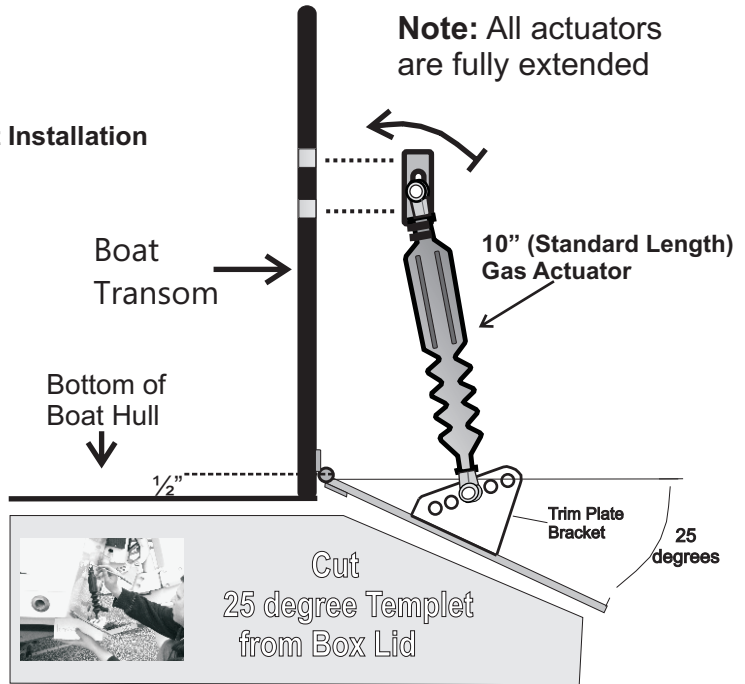
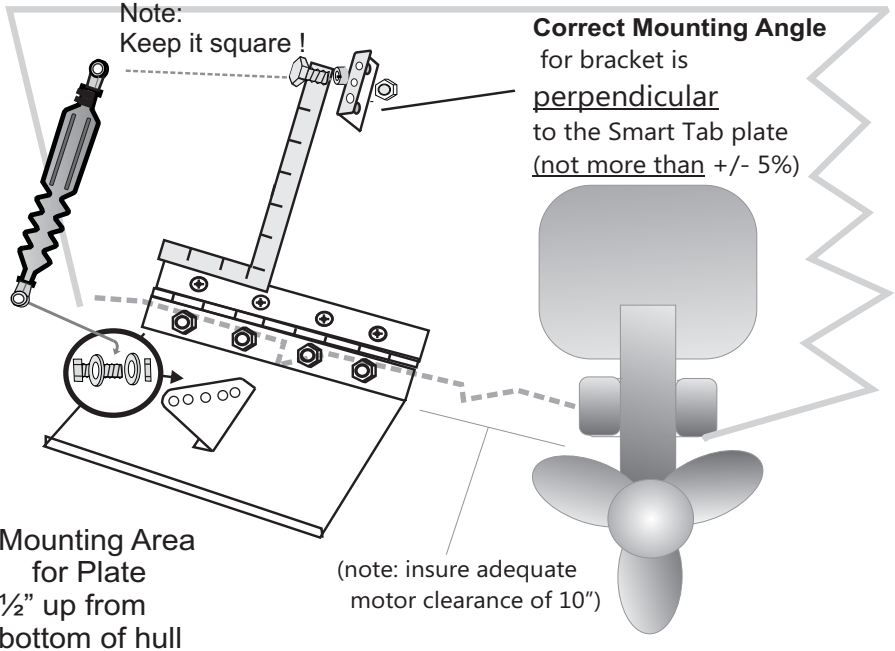

Fig. #3B

Transom Bracket Installation
Perpendicular to the Trim Plate



Adjusting Smart Tabs for Your Boat :

(Conduct a trial run before making any adjustments!)

1 - Smart Tab “Lift” Pressure - Start At the Mid Point! (see Fig. 4 “A” on page 9)

Purpose:

The plate bracket holes (#1 through #5) allows you to increase or decrease the amount of “LIFT” pressure that the Smart Tabs will provide to optimize the performance of your boat. Hole #1 is least pressure and hole # 5 is most. The balance of your boat is important to its overall performance.

A Heavy Rear End Needs More “Lift”:

If your boat has more stern weight, increasing the “LIFT” pressure will bring the boat on plane more quickly. Move the actuator attachment **UP** from hole #3 to hole #4 for example.

IMPORTANT NOTE: Too much STERN lift can cause too much BOW pressure at cruising speeds which will **REDUCE** the TOP Speed and cause bow steering problems. If this occurs reduce the lift pressure.

A Lighter Rear End Needs Less “Lift”:

If your boat is more balanced you may wish to decrease the “LIFT” pressure. Move the actuator attachment down from hole #3 to hole #2 for example.

Notice: Adjusting the ball stud position on this bracket does not change the up or down angle of the plate. This adjustment is for changing lift pressure.

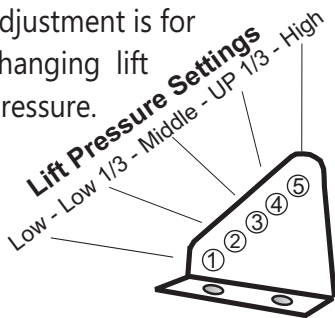

Tri. Plate Bracket

2 - Smart Tab Plate Angle - Start with 25 degrees! (see Fig. #4 “B” on page 9)

Purpose: The **Transom Bracket** allows you to adjust the starting angle of the Smart Tab Plate which can compensate for transom angle. The recommended range limit is between 20 and 30 degrees down from the parallel line of the hull.

Power to Weight Ratio: If your boat has a **high powered** engine (for the size of the boat) you may wish to increase the starting angle to 30 degrees (down) which will provide more “LIFT” in the early stages of acceleration. If your boat is more **modestly powered** you may want to limit the starting angle to 20 to 25 degrees, which will allow early acceleration to facility maximum “LIFT”.

Note: Before making this adjustment conduct a sea trial. Too much starting angle (i.e.: 35 to 40 degrees) will turn the Smart Tabs into **BRAKES** Do not exceed 25 degrees.

Fig. #4

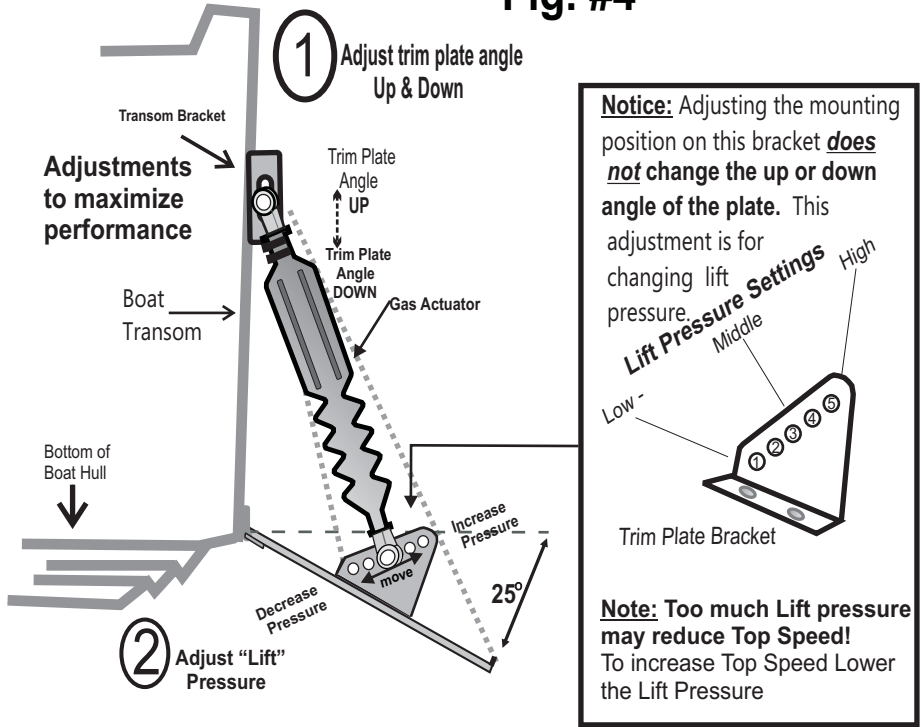

Optional # PR500 Bracket for use as Plate Retractors

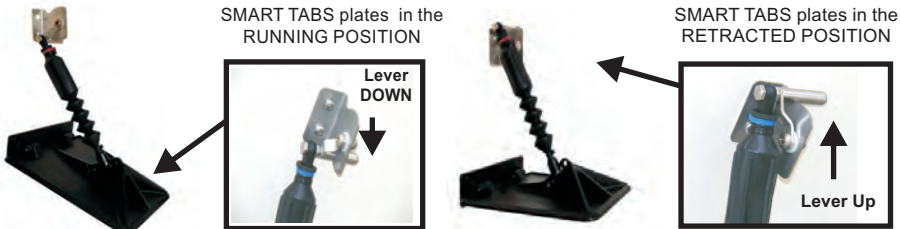

The PR500 Bracket Kit assembly allows you to set the Smart Tabs in two different positions without the use of any additional tools. When the bracket handle is in the "Down" position the Smart Tabs will function as trim tabs. When the bracket handle is in the "UP" position Smart Tabs will be fully retracted.

Note: For this application the "Lever Handle" must be in the "DOWN" position during installation. Supplemental instructions are provided with the PR500 kit. Follow the instructions on Page 6 of the installation manual and substitute the PR500 Bracket for the standard Transom Bracket.

Adjustments for List:

Since Smart Tabs adjust themselves, compensating for any list caused by load imbalance or prop torque, is only recommended if the list is constant.

This adjustment is usually done only once, at the same time the lift pressure is adjusted. It is highly recommended that this adjustment be made only if the boat has a noticeable list at normal cruising speeds.

Compensate for the list by increasing the lift pressure on the same side to which the boat is listing. **Do not change the Trim Plate angle, as this will cause steering problems!**

Note: If the list is due to load balance, make sure that this is a permanent condition, and not due to temporary equipment or passenger seating arrangements.

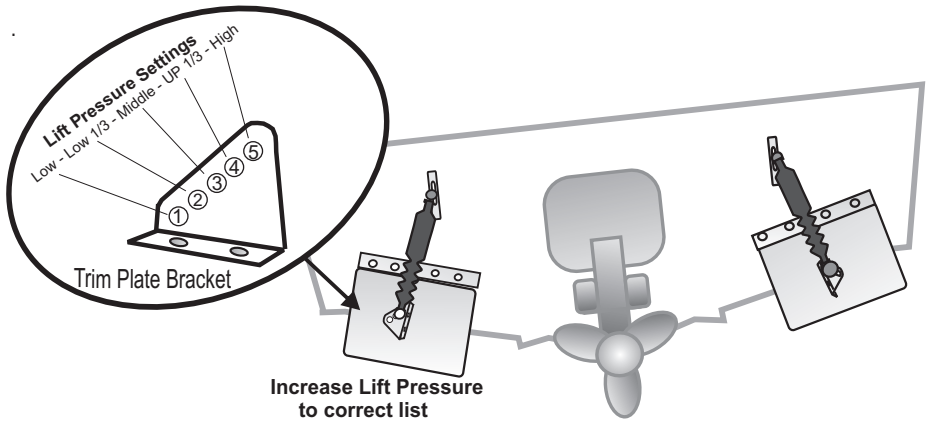

Supplemental Installation: (refer to additional sheets inclosed for ST781)

Align and tape template to port side of boat first. Right side of hinge outline on template should be 7 3/4" from center line of boat.

Mark 2 holes for Transom bracket and 3 holes for hinge, then drill with 1/8" bit.



Turn Template over and repeat steps on starboard side.

Note: End Fittings may be rotated and Brackets reversed to accommodate installation requirements.



Installation Examples

Inflatable Boats



10 ft. soft bottom



16 ft. Rib

More Traditional Transom Boats



with sensors, transducers, & ladders



Contoured & Molded Swim Platforms

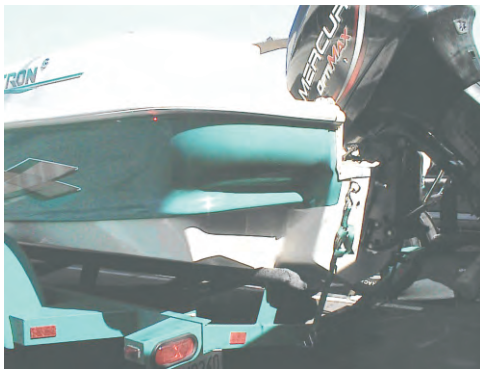
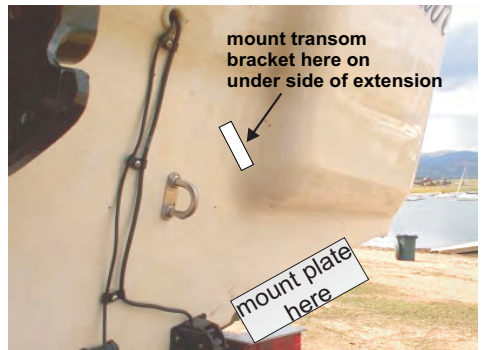
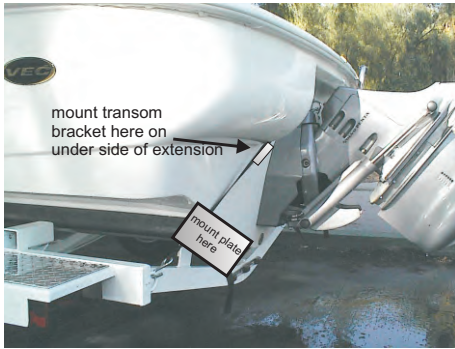

If you have limited height clearance then use the holes furthest back on the trim to mount the plate bracket. Fill the other hole with the black push pin provided to you. If you need to use Zinc then you may use this additional hole.

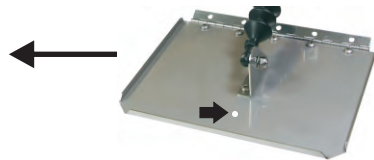

Notice: Use in SALT WATER requires the use of zinc anodes.

Maintenance

Metal parts

All of the Smart Tabs metal components are made from corrosion resistant #304 or #316 Stainless Steel, and therefore require minimal maintenance. Normal cleaning and inspection will be sufficient for these parts.

Gas Spring Actuator

The Gas Actuator with the protective rubber boot is the heart of the Smart Tabs system, and requires some attention. The specially designed boot is sealed to keep dirt, water, and corrosive chemicals from damaging the actuator shaft.

Follow these simple steps to extend the performance and life:

1. When not in use it is good to occasionally compress the actuator by raising the trim plate to a horizontal position or higher several times. This keeps the shaft lubricated. The Actuator may be stored in the compressed position.

Note: If the boat is stored on a trailer, load the boat onto the trailer first. As an option you may wish to remove the actuators from the boat.

2. Inspect the protective rubber boot for any holes, rips, or tears. If any are found, remove the actuator as soon as possible and replace the boot. If the shaft of the actuator is damaged or corroded, replace the actuator.

TIP: To **check the boot for holes**, simply raise the trim plate (compressing the actuator) and observe the bellows. If properly sealed the bellows will hold in the compressed air.

Common Questions and Answers and Problems!

Q: The Actuator seems to be frozen or too stiff?

A: The Actuator pressure is directly related to the amount of lift required for your boat. Larger heavier boats require more lift at the stern. The plate and actuator pressure need to be sized to fit your boat. Make the adjustment as shown on pages 8 to 10, and they will work properly.

Q. The boat is not as fast as it was before using Smart Tabs?

A: Your Boat should be more efficient and increase Top Speed. There are two probable causes which require a simple adjustment. 1. Boats without Electric Trim -Before installing Smart Tabs you may have the motor "Trimmed" into the transom so that the boat planed quicker. This is no longer necessary, and should adjust the trim rod out one or two holes down. You will regain the speed and improve efficiency. 2. Smart Tabs may be incorrectly adjusted with too much pressure. Refer to pages 8 to10, and reduce the pressure.

Q. The boat does not plane any better with Smart Tabs?

A. If the correct model has been chosen increase the lift pressure (refer to pages 8 to 10). If increasing the pressure does not give satisfactory results, call customer service for assistance.

Q. How do I keep the Smart Tabs up for beaching, trailoring, or placement on charks?

A. Refer to page # 9 for Storage and Beaching instructions.

Q. The boat is unstable at high speeds?

A. On fast boats this is called chine walking. The boat is running on a very small part of the hull. Increasing the lift pressure will permit Smart Tabs to resist the side to side movement and stabilize the boat.

C u s t o m e r S e r v i c e

Once you have read the installation and owners manuals, and taken a test ride in your boat, please feel free to call Nauticus with any questions or for technical assistance. Your complete satisfaction with Smart Tabs is our goal. You may contact us at the address below or call during business hours which are: Monday to Friday 9:00 AM to 5:00 PM eastern standard time.

8080 Snowville Rd. - Brecksville - Ohio - 44141
Tel: 440-746-1290 . Toll Free: 800-233-0194 . Fax: 440-746-1291
Web Site: www.NauticusInc.com



Limited Warranty

Nauticus, Inc. Warrants to the first retail purchaser of this product that it is free from defects in material and/or workmanship for a period of:

Five (5) years on all Metal Components

Two (2) years for rubber Boot Covers and Gas Springs, from the date of purchase.

The proper operation of this product is dependent upon your compliance with the Installation and Owners Manual instructions regarding installation, operation, maintenance and testing. Failure to comply with the instructions may void the warranty. If during the period of this warranty, it appears as though this product or component has a defect, call our Toll Free number for assistance and instruction (800-233-0194).

This Limited warranty is in lieu of any other warranties, express or implied. This warranty does not cover non-defective damage, damage caused by improper installation, operation or care (including but not limited to abuse, misuse, failure to provide reasonable and necessary maintenance, or any alterations to this product), labor charges for removal or reinstallation. Under no circumstances shall Nauticus Inc. be liable for consequential, incidental or special damages arising in connection with the use, or inability to use, this product. In no event shall the liability of Nauticus Inc. exceed the cost of the product covered hereby.

Notice: Use in SALT WATER requires zinc anodes.

Some states do not allow the exclusion or limitation of consequential, incidental or special damages, so the above limitation or exclusion may not apply to you. This limited warranty gives you specific legal rights, and you may also have other rights which vary from state to state.

Important Information Bulletin

They are NOT Stuck or Frozen!!!

The Smart Tabs Actuators are coordinated with the appropriate kit to provide the necessary lift to the stern of the intended boat.

If the correct Smart Tabs kit is used the actuator will hold the trim plate down until the boat reaches the minimum planing speed. The actuators will then come UP!

Trying to compress the actuators with your hands may not be possible. These actuators will require at least 60 to 80 pounds of force respectively before they compress. The last two numbers of the actuator indicate the pounds of pressure required to compress the actuator.

When installed on the boat the water pressure will push the trim plates up! This water pressure is what will lift the stern and provide the level ride.



Example:

ST1290-80 Actuators require 80 lbs. of force to compress the Actuators



Technical assistance

1-800-233-0194

Installation Angle Template on Reverse Side

Cut along Dotted Line

Note:

Hinge Template for 6", 8", 10" Lengths

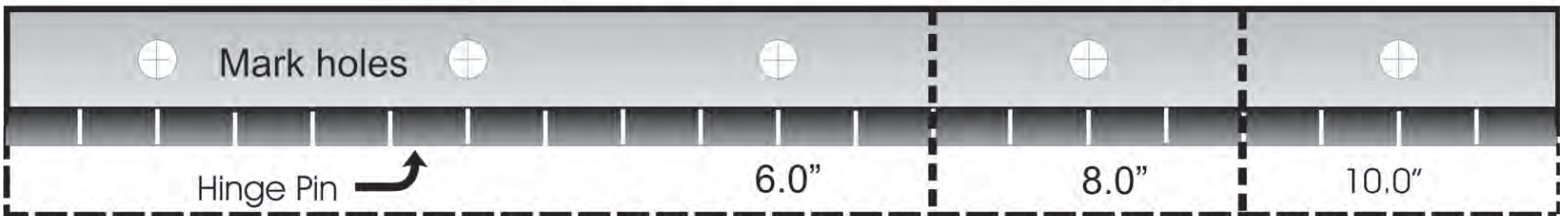

Align dotted line with bottom edge of hull (hinge pin /plate will be 1/2" up from bottom)

REMOVE FROM MANUAL

Smart Tab Installation angle template



Cut
25 degree Template
from Box Lid

Nauticus Incorporated 1-800-233-0194
www.nauticusinc.com